

Structural Engineering Foster + Partners



Foreword

Our philosophy is that the best projects arise from a totally integrated approach to the design process, where the core disciplines work together to conceive and design a project from its earliest inception.





Above: Tocumen International
Airport Panama.

Left: Cleveland Clinic Ohio,
USA.



Contents

1 Practice Overview

- Our approach
- How we work
- The Partnership

2 Engineering

- What we do
- Structural Engineering
- Building Information Modelling

3 Engineering Team

- Key Members

4 Selected Projects

- Apple Union Square, San Francisco, USA
- Oceanwide Center, San Francisco, USA
- Apple Dubai Mall, Dubai, UAE
- UAE Pavilion, Milan Expo 2015, Milan, Italy
- 425 Park Avenue, New York, USA
- Apple Zorlu Centre, Istanbul, Turkey
- Cleveland Clinic Medical School, Ohio, USA
- Apple Westlake, Hangzhou, China
- Keruen 2, Astana, Kazakhstan
- Apple Regent Street, London, UK
- Tocumen International Airport, Panama City, Panama
- Château Margaux, Bordeaux, France
- Hongqiao Vantone SunnyWorld Centre, Shanghai, China
- Musée Régional de la Narbonne Antique, Narbonne, France
- Marseille Vieux Port, Marseille, France
- Maggie's Centre at the Christie, Manchester, UK
- New International Mexico Airport, Mexico City, Mexico
- Ocean Towers, Mumbai, India
- MOL Campus, Budapest, Hungary

Left: Apple Union Square, San Francisco, USA.



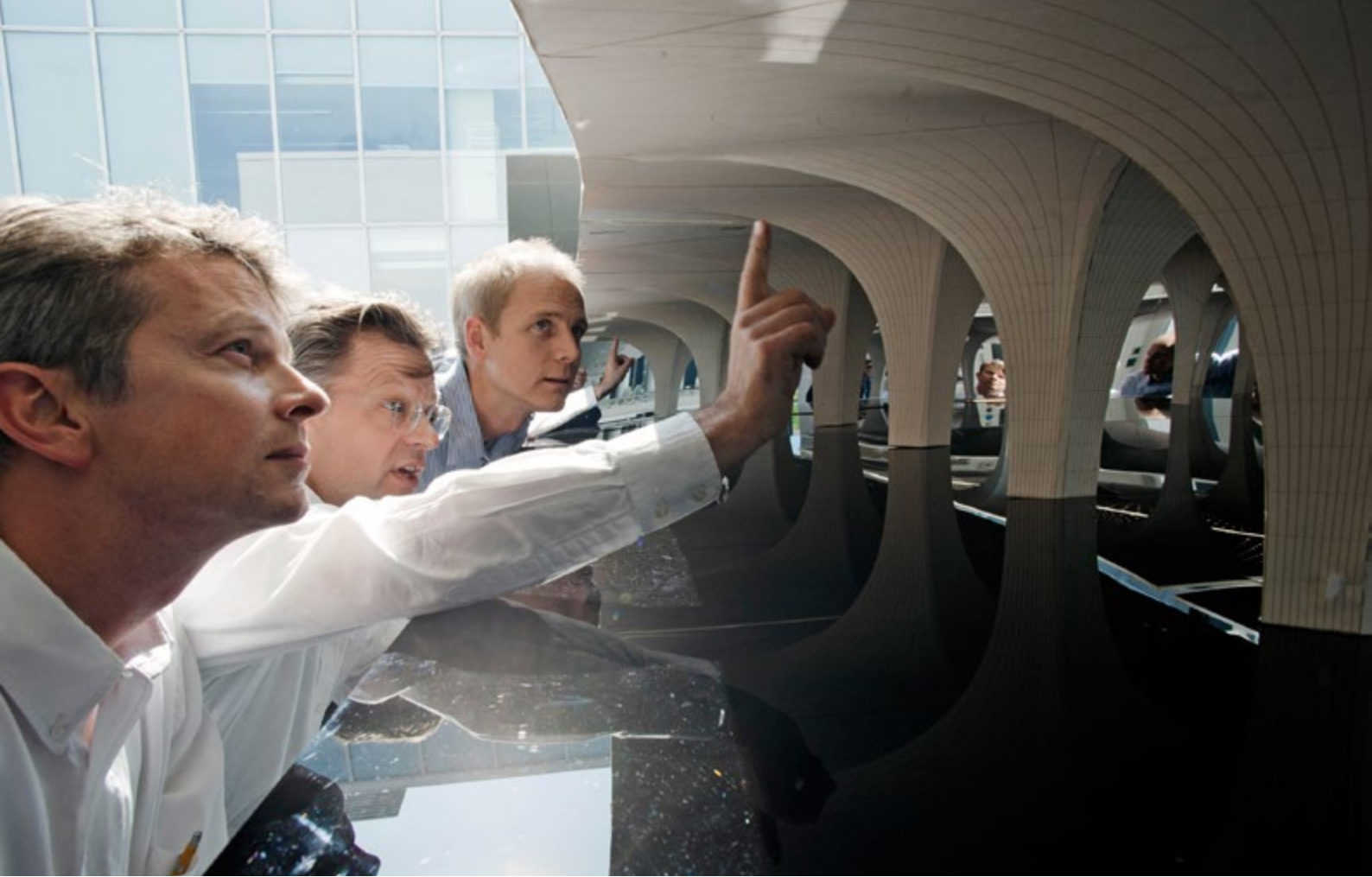

Our approach

Foster + Partners is a global studio for sustainable architecture, urbanism and design, founded by Norman Foster in 1967. Since then, he and the team around him have established an international practice with a worldwide reputation. With offices across the globe, we work as a single studio that is both ethnically and culturally diverse.

Sustainability is at the heart of everything we undertake. We audit all projects against global standards, while developing bespoke strategies that drive our environmental agenda. To build sustainably requires us to design holistically, and our unique integrated design approach enables us to develop innovative strategies that have a firm focus on the future of the environment.

Structural and environmental engineers, together with many other specialist design teams, work alongside the architects to devise fully integrated design solutions. Every project starts with fresh thinking, leading to a solution that is tailor-made to both site and user. Design is typically undertaken by a small, close-knit team; the team that starts a project sees it through to completion, thus providing continuity throughout. It is now possible to consider the built environment as a totality, and to apply a truly holistic approach to responsible design.



Foster + Partners recognises sustainability as central to any design project and strongly believe it should be considered from the beginning of the project and throughout the design process.

How we work

Architecture

We believe the best architecture comes from a synthesis of all the elements that separately comprise and inform the character of a building: the structure that holds it up; the services that allow it to function; its ecology; the quality of natural light; the symbolism of the form; the relationship of the building to the skyline or the streetscape; the way you move through or around it; and last but not least its ability to lift the spirits. By working together creatively from the start of a project, architects and engineers combine their knowledge to devise integrated, sustainable design solutions.

Design Communications team review in
The Hub at Foster + Partners studio in
Battersea, London.



Design Management

Using the most up-to-date project management standards, the Design Management team provides support to the design teams. We play a key role throughout the design and construction phases, from programming, change control, and procurement to document control, payments and risk management.

Design Support

At Foster + Partners, design is typically undertaken by a small, close-knit team of individuals, which is able to draw on a wide range of other disciplines including, communications, graphics, visualisation, film, model making, and 3D computer modelling.

Design Communications

To help design teams visualise projects, the Design Communications group produces a wide range of work, from hand-drawn sketches, drawings, digital concept art paintings to photorealistic artwork.

Visualisation and Film

The Visualisation and Film group produces architectural visualisations, animations, motion graphics and films for the practice for use at concept stages, construction, marketing and final presentations.

Modelmaking

Assisting the teams throughout the design process, the modelmaking team creates everything from sketch models to large-scale building mock-ups, using a wide range of tools from traditional techniques and styles to innovative new technology.

Environmental Engineering

The Environmental Engineering team designs efficient building systems that reduce energy and water consumption, enhances user comfort and ensures indoor environmental quality. There are many aspects to the team's work including: Mechanical Engineering; Electrical Engineering; Public Health; Fire Protection; Vertical Transportation; Architectural Lighting Design; Building Physics and Sustainability.

Industrial Design

Carrying out a diverse range of work, the Industrial Design team frequently works as an integral part of the overall studio, designing specific building elements, but also developing products at a commercial and domestic scale in collaboration with industry partners such as, lighting products for Lumina and Louis Poulsen, furniture with Walter Knoll and Vitra, and nautical commissions for YachtPlus and other private clients.

Below, from the top:
Visualisation team's video editing suite.
An offsite modelshop located on
Stewarts Road, close to the main studio,
in London.
Narbo Via, aerial view visualisation.



Interiors

By designing a building from the inside-out as much as from the outside-in, we inculcate a sense of continuity and connection to the wider world. The starting point for any design solution is to gain an understanding of people's needs and the way in which a space will be used. The goal is the creation of interiors that are both functional and elegant, while evoking a sense of place and complementing a building's outward expression.

Research

Central to our ethos is an appetite for enquiry, discovery and understanding. By maintaining a commitment to research – one of our great strengths as a practice – we are not only up-to-date with new developments and techniques, but are also able to thoroughly evaluate their relevance and technical performance for individual projects. Our research groups such as, Applied Research and Development, Material and Research Centre, and Specialist Modelling Group, help design teams answer these challenges in the spirit of innovation.

Applied Research and Development (ARD)

To solve complex design challenges, bringing the latest advances out of the lab and into the hands of architects and engineers, the ARD team conducts state-of-the-art research and development at the practice. The team provides expertise in computational design, performance analysis, optimisation, fabrication and interaction design.

Specialist Modelling Group (SMG)

SMG focuses on three core areas, Geometry and Building Physics and Innovation. The Geometry team works on complex geometrical modelling and fabrication strategies. The Building Physics team looks at the movement of natural light, air and sound, while focussing on occupant comfort. The Innovation projects include collaborative research with universities and industry partners, exploring far-reaching ideas from bio-inspired engineering to extra-planetary 3D printing.

Materials Research Centre (MRC) and Information Centre (IC)

Providing an information and research service for the practice, the MRC and the IC together look at current and new materials, products, companies, technology, innovation, sustainability and technical issues. The MRC is an in-house reference that houses over twenty thousand samples of materials and products. The IC is a physical library of product literature including brochures, catalogues and technical information.

This page, from the top:

Industrial Design team developing Eva table light with Lumina in Italy.

Villa La Voile, Saint-Jean-Cap-Ferrat, the southern wall of the living space is fully glazed and can be slid aside to open the space up to sunlight and sea air.

Interactive Physical Modelling application, created by ARD team.

Model of Mars Habitat, a project by the SMG.

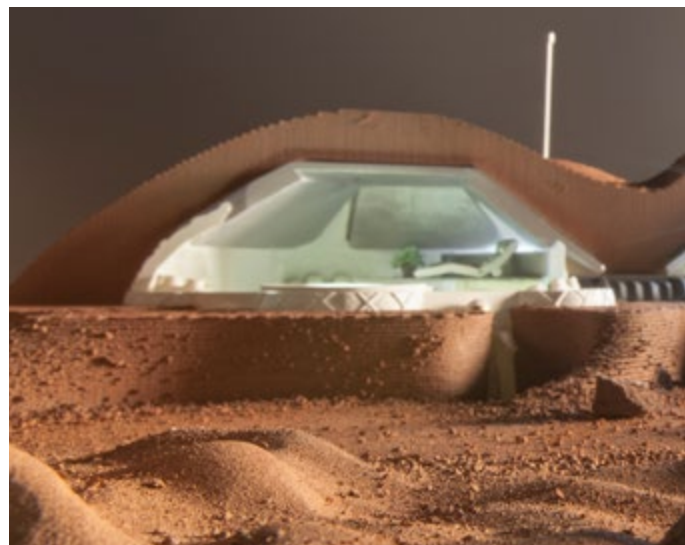

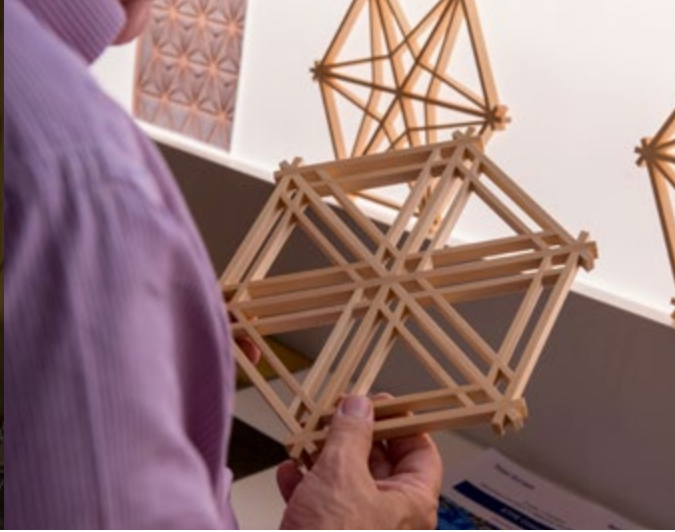

Structural Engineering

The Structural Engineering team has experience in tall and complex buildings, and particular knowledge of non-linear and seismic design and analysis. The team works on projects from their initial conception right through to completion on site together with the architectural teams. They also liaise with other engineering consultants on projects, where the knowledge of local codes and third-party procedures may be beneficial.



Sustainability

Acting as a catalyst for thought leadership at the practice, the Sustainability Group looks at ways to advance our sustainable design processes. Working directly with the design teams, it delivers insight, informs direction, and measures improvements, to develop a sustainable vision for projects carried out by the practice.



Urban Design

The design of the public realm is arguably more significant than the collective merits of the individual buildings. The Urban Design Group consists of specialists from a range of backgrounds – including landscape architecture, anthropology, economic development, sociology, urban analysis and computation. By gaining a detailed understanding of context, the group helps to develop projects that are tailored to specific socio-economic, climatic and spatial circumstances.

Workplace Consultancy

As team of designers, analysts and researchers, the Workplace Consultancy are dedicated to matching architectural and interior design with business objectives and changing needs of organisations. We explore and envision the future of communities, cultures and corporations and how these will influence our built environments. We work with clients to understand their needs and we undertake post-occupancy surveys to learn from practical experience.



This page, top three images:

Material Research Centre at Foster + Partners studio in Battersea, London.

Tree-like columns of Nouveau Chai at Château Margaux in Bordeaux, France.

Interior view of the cupola at the Reichstag, New German Parliament, Berlin.

The Partnership

The strategic direction of the practice is set by the Partnership Board (shown below, left to right): Norman Foster, Stefan Behling, Grant Brooker, Nigel Dancey, Spencer de Grey, Gerard Evenden, Luke Fox, David Nelson, Matthew Streets and David Summerfield.

The day to day management is provided by the Management Board. Allied with this is a core group of partners, who are central to the continuing evolution of the practice. Holistic design direction is provided by the Design Board, which has overall design responsibility for every project, from the start of the design process through to construction drawings.



“From the very beginning our practice was founded on a philosophy of innovation, sustainability and design. We continue to learn from the past and creatively embrace the challenges of the future, with a firm belief that good design makes a difference.”

Norman Foster

Executive Chairman and Founder, Foster + Partners



What we do

Our integrated approach to design delivers the best value for the client through high level support during all design stages, rapid evolution optimisation and testing of design ideas, a single point of contact, and a single modelling environment.

Our engineering teams are co-located with the architectural project teams, working alongside them coordinating design, analyses and systems development, managing a shared BIM model and sharing information in a single modelling environment as the project develops.

We are also accustomed to working in partnership with other technical specialist practices and local partners. We favour an open approach, sharing and reviewing information fully, and optimising the design through the adoption of the best ideas.

Below and right: Regular reviews across the different disciplines ensure high quality of design output





Structural Engineering

The Structural Engineering team has experience in tall and complex buildings, and particular knowledge of non-linear and seismic design and analysis. The team works on projects from their initial conception right through to completion on site together with the architectural teams. They also liaise with other engineering consultants on projects, where the knowledge of local codes and third-party procedures may be beneficial.

Vatican chapel, Venice.



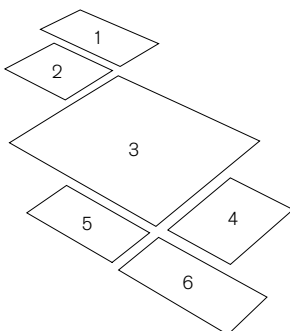
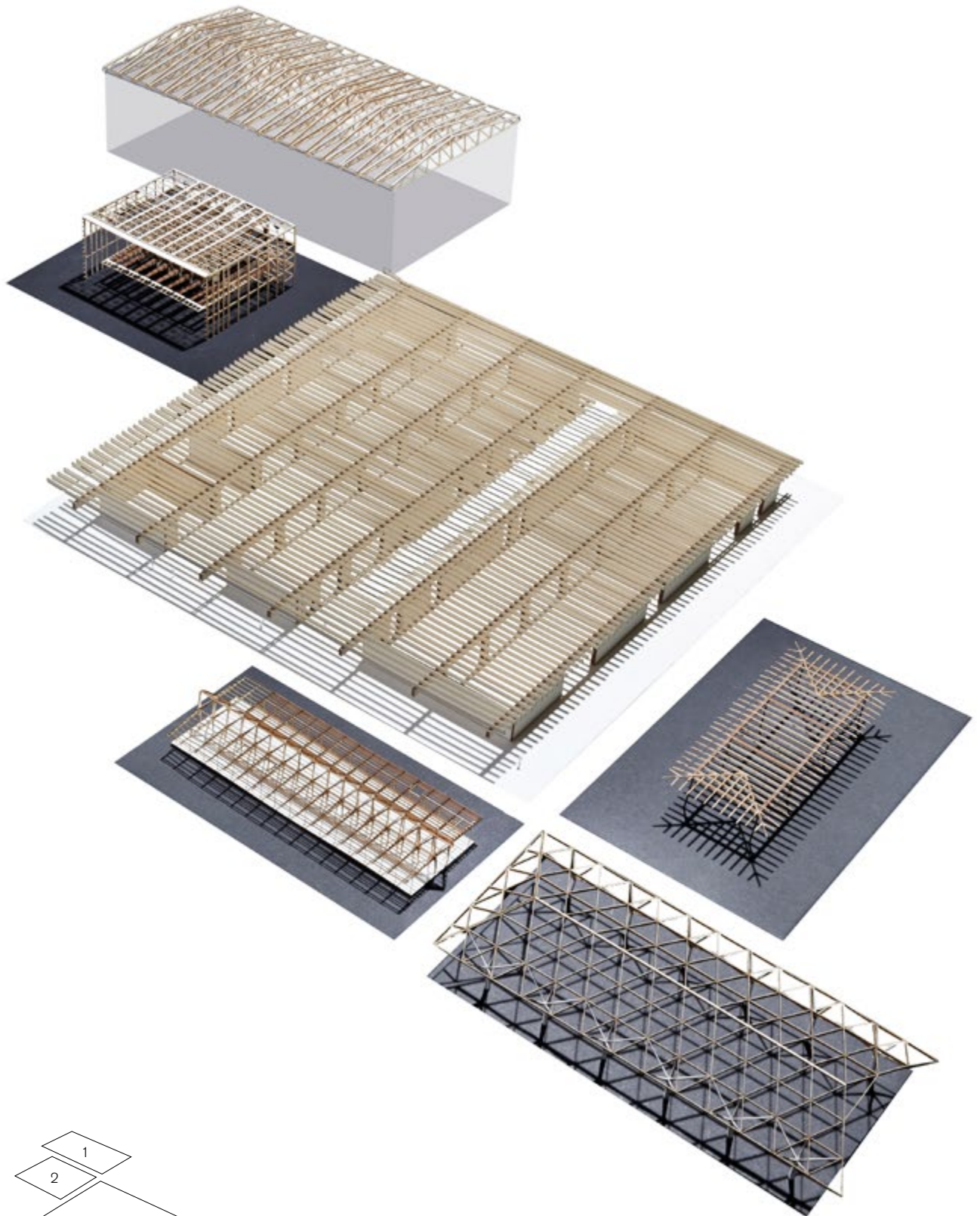

1. Cleveland Clinic Medical School
2. Apple Store Westlake
3. Musée Narbo Via
4. Marseille Vieux Port
5. Maggie's Centre Manchester
6. Château Margaux

Building Information Modelling

Building Information Modelling (BIM) is transforming the way buildings are designed, built, planned and operated.

Foster + Partners uses different tools and software applications across all platforms and disciplines to design and optimise buildings in response to specific project requirements. The BIM process is a key component of our integrated design approach for all scales of projects.

It involves data-centric 3D models to produce design and construction drawings, calculations, interference checks and visualisations among others. In addition we have the opportunity to extend the workflow for construction cost estimation (4D) and design optimisation by working directly with fabricators and manufacturers as well as for construction scheduling and just-in-time delivery to site (5D).

The process allows us to work at a fast pace with different disciplines for coordination, and we can also use the output to drive our in-house 3D printing and virtual reality suits to aid the review process and communication of design.

Employing an integrated approach to BIM enables Foster + Partners to be highly flexible with project teams, allowing scalability and deployment on different aspects of the design as projects develop.

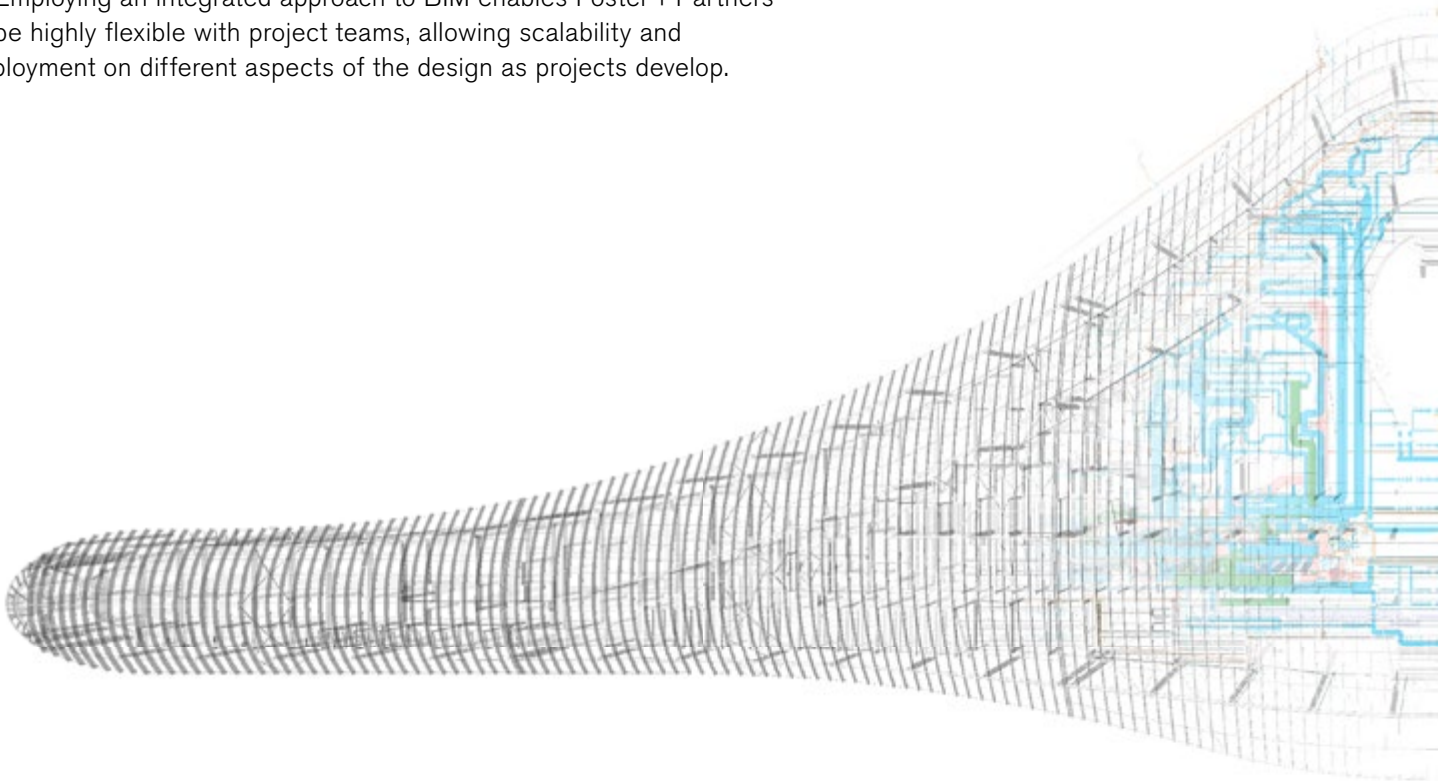

Above: Excerpts from the Tocumen International Airport centralised BIM model, used to coordinate structure and mechanical services

Section showing integration of engineering services with structure and architecture.

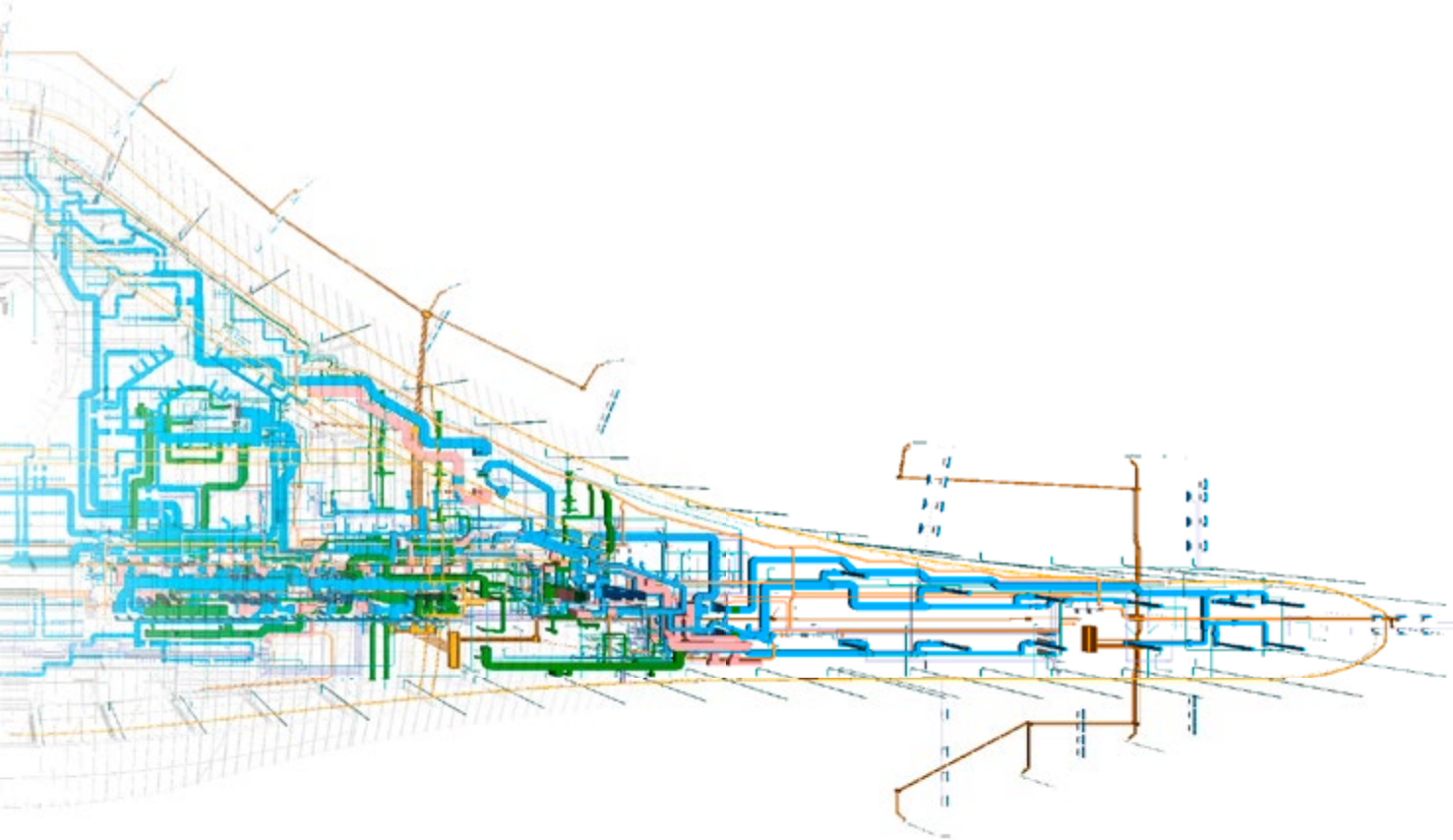
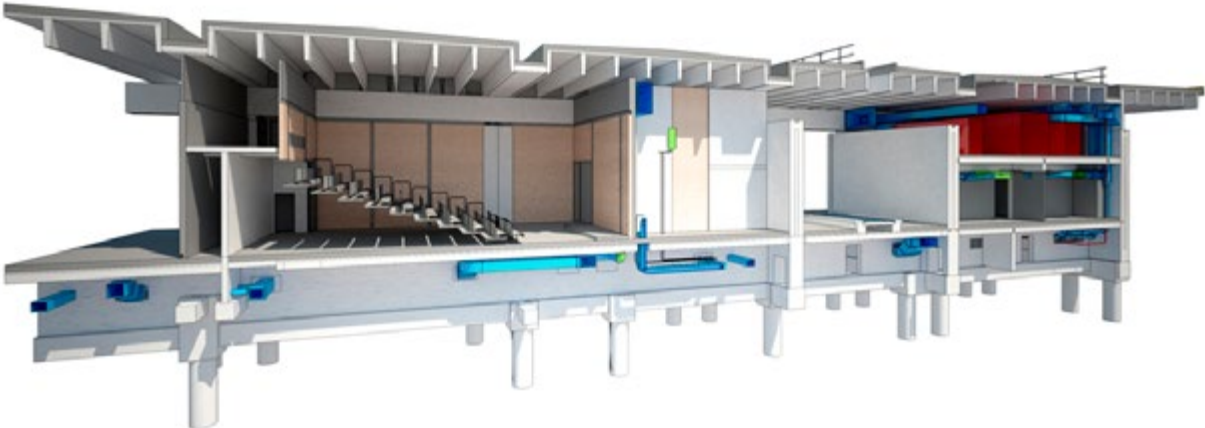



Engineering Team

Key Members

3



Roger Ridsdill Smith

MA (Cantab) CEng FStructE P.E. (NY) S.E. (UT)
 Fellow of Institution of Structural Engineers
 Senior Partner, Structural Engineer

Roger Ridsdill Smith leads Foster + Partners' Structural Engineering team. He gained his degree in structural engineering from Cambridge University and began his professional career in Paris. In 1994 he joined Ove Arup and Partners, becoming a director of the firm in 2003 and subsequently running a multidisciplinary engineering group in Arup's London office. His experience includes the design and construction of structures around the world, as well as leadership of multidisciplinary design teams on major projects.

While working for Arup, he was involved in frequent collaborations with Foster + Partners, including the Faustino Winery in Spain, the headquarters for Citibank, as well as the Pride Tower, both in Canary Wharf, and the Millennium Bridge in London. In 2011 he joined Foster + Partners to establish a creative engineering group, bringing integrated engineering design to all the practice's projects.

The Structural Engineering team within the practice has been built on the basis of technical excellence, with an emphasis on the design of complex structures.

Recently completed projects include the Chateau Margaux winery in the South of France; and the Maggie's Centre at The Christie in Manchester, built in structural timber, and the winner of the Wood Awards Arnold Laver Gold and the Structural one. The team has also developed the original structural concept for the competition winning tower for 425 Park Avenue in New York. Other recent projects include the new Tocumen International Airport terminal in Panama City, Panama, the Cleveland Clinic in Ohio, USA and the New Museum of Archaeology in Narbonne, France.

Roger is a licensed Professional Engineer in the State of New York. He is a Fellow of the Institution of Structural Engineers, and an Honorary Senior Lecturer at Imperial College in London. He has won several prizes for his engineering work, including the Royal Academy of Engineering 2010 Silver Medal and the IABSE (International Association for Bridge and Structural Engineering) Milne Medal Award in 2017.

1. Marseille Vieux Port, Marseille, France
2. Chateau Margaux, Bordeaux, France
3. Maggie's Centre at The Christie, Manchester, UK
4. Cleveland Clinic, Ohio, USA
5. Tocumen International Airport, Panama City, Panama
6. Ocean Towers, Mumbai, India
7. Millennium Bridge, London, UK

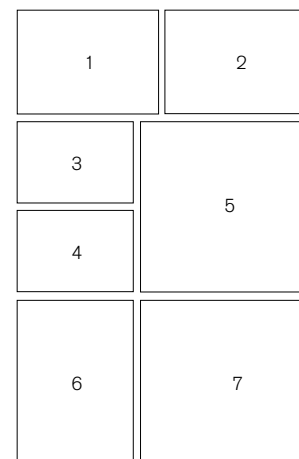



Andrea Soligon

P.E. (CA) Ing. MSc Laurea
Partner, Structural Engineer



Andrea Soligon, P.E. joined Foster + Partners in 2011 to establish the Structural Engineering team, which brings integrated engineering design to projects across the practice. He became a partner in 2012 and has been the structural partner in charge responsible for the structural design of the new 82,000m² south terminal at Tocumen International Airport in Panama designed as an essential facility using the seismic performance-based methodology, the 66,000m² Keruen 2 suspended office tower and retail podium in Astana, Kazakhstan, and for the structural concept for the competition winning scheme for the 260m tall tower at 425 Park Avenue in New York.

In addition to large scale projects, Andrea has delivered the structural design of other special smaller-scale buildings including the Chateau Margaux winery and the Marseille Vieux Port canopy in France, the UAE Pavilion at the 2015 Milan Expo in Italy, which was designed in structural steel as a demountable building, and its relocation to Masdar in the UAE.

Andrea is currently leading the structural design and Construction Administration of a further expansion of Tocumen International Airport in Panama.

Prior to joining Foster + Partners, Andrea worked in London with Arup and in New York City with Leslie E. Robertson Associates, where he gained significant experience and contributed to the design of landmark structures such as the 492m tall Shanghai World Financial Center in China, the Newseum and Freedom Forum in Washington, DC and the William J. Clinton Presidential Center in Little Rock, AR.

Andrea studied Structural Engineering at the University of Padova, Italy and went on to receive his Masters of Science degree in Structural Engineering from the University of California, Berkeley. He is a registered Professional Engineer in the state of California and Italy. He is a member of the American Society of Civil Engineers (ASCE), the American Institute of Steel Construction (AISC) and the American Concrete Institute (ACI).

Right: Keruen 2, Astana, Kazakhstan

Below left: Tocumen International Airport, Panama

Below right: UAE Expo 2015 Milan, Italy



Adrian Parkinson

MSc BSc BA P.E. (CA) S.E.(CA)

Partner, Structural Engineer



Adrian studied at University of California at Davis, graduating with a BA in Studio Art and a BSc in Civil Engineering with Structural Emphasis. He went on to obtain a Master's Degree in Structural Engineering and Mechanics of Materials from the University of California at Berkeley, graduating in 1997.

In 1996, Adrian began his career at DASSE Design in San Francisco, where he returned after completing his Master's Degree. At DASSE Design, Adrian was involved in a variety of seismic-resistant design projects throughout California, including high-rise retrofit, schools, hospitals, and commercial facilities. These early years in San Francisco saw the development of performance-based seismic design, which standards are now recognized worldwide.

In 2000, Adrian moved to New York where he worked at Leslie E. Robertson Associates. Adrian worked on many iconic projects such as I.M. Pei's Museum of Islamic Arts in Doha, Qatar, as well as towers such as the 1614 ft-tall Shanghai World Financial Center. As a Senior Associate at LERA, Adrian was the structural Project Manager for Tower 4 of the New World Trade Center which stands at 947ft (288m) tall.

In 2008, Adrian returned to the west coast where he joined Nabih Youssef Associates. At NYA, Adrian continued his focus on seismic-resistant design, having worked primarily on the New Stanford Hospital which is designed to an enhanced performance criteria and employs a sophisticated base isolation system.

In 2013, Adrian joined Foster + Partners' structural engineering team in California. With a speciality in seismic-resistant design, Adrian is deeply involved in carrying out the Integrated Design Approach embraced by Foster + Partners. Adrian has been involved in significant projects such as the Tocumen Airport in Panama, the Oceanwide Tower in San Francisco, and Apple Campus and Retail projects. Adrian recently led the structural development of the Union Square Apple Store in San Francisco. In 2015, Adrian moved to London and was promoted to partner in 2016.

Adrian has particular interests in advanced analysis techniques and performance-based seismic design, not as abstract engineering methods, but particularly as tools that help make landmark architecture a reality. Adrian's work has been featured in Civil Engineering Magazine and in Architectural Record.

Left to right:

Tocumen International Airport, Panama

Apple Union Square, San Francisco, USA

Oceanwide Centre, San Francisco, USA

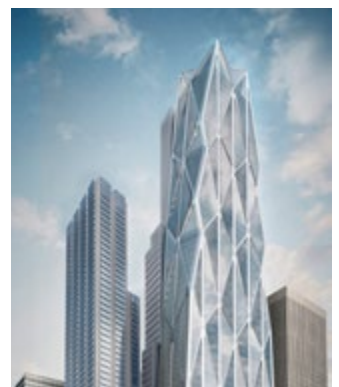



Xiaonian Duan

BEng MSc PhD CEng MIED
Partner, Structural Engineer

Dr Xiaonian Duan studied civil and structural engineering at Tsinghua University, China, gaining his BEng and MSc degrees. He then obtained a joint Sino-British Technical Cooperation scholarship to pursue research in Structural Earthquake Engineering at University College London, obtaining his PhD. In 1996 he joined the Advanced Technology Group of Ove Arup and Partners as a structural seismic engineering specialist after his post-doctoral research fellowship at UCL. During his 14 year career at Arup, he was the leading force for making their structural seismic engineering a global practice and for developing its technical excellence. He has been instrumental in the success and the structural engineering excellence of many landmark building projects worldwide, such as the CCTV Tower in Beijing and the Shenzhen Stock Exchange building.

He is an internationally recognised expert on seismic analysis and design of structures, and on tall building structural design. He has extensive experience and expertise in the analysis and design of a wide spectrum of structures including buildings, bridges, nuclear power safety-related structures, offshore and onshore oil and gas structures, onshore Liquid Natural Gas storage tanks and industrial equipment worldwide including the landmark Yas

Hotel spanning over the Yas Marina Formula 1 racetrack in the Middle East. His particular expertise is in performance-based seismic design and nonlinear response history analysis of tall buildings and has served in the Seismic Working Group and Review Panel of Council of Tall Building and Urban Habitat on performance-based seismic design guideline documents of tall buildings.

He joined Foster + Partners in 2011 as a structural partner to work on integrated architectural and engineering designs of buildings across the globe. After joining the practice, he has been the structural partner in charge of the practice's first integrated architectural and engineering commission – the mixed use Shanghai Hongqiao Vantone and SunnyWorld Centres (currently near completion), successfully passing the structural expert panel review for special approval. He then served as the co-structural partner in charge with Andrea Soligon for the Tocumen International Airport South Terminal (currently near completion) in Panama City, Republic of Panama for the successful delivery of a full structural engineering service. He is currently leading the structural design of a 93 storey twin towers project in India.

Left to right:

Tocumen International Airport, Panama

Hongqiao Vantone SunnyWorld Centre, Shanghai

Ocean Towers, Mumbai, India

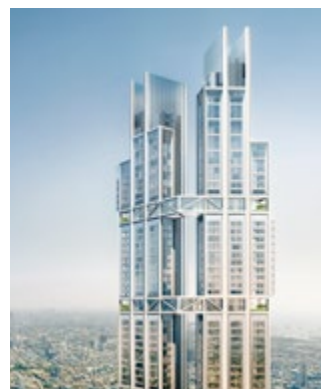



“Our design goal is to achieve a design that seems inevitable, that has integrity, that looks like nothing can be removed.”

Roger Ridsdill Smith

Senior Partner, Head of Structural Engineering

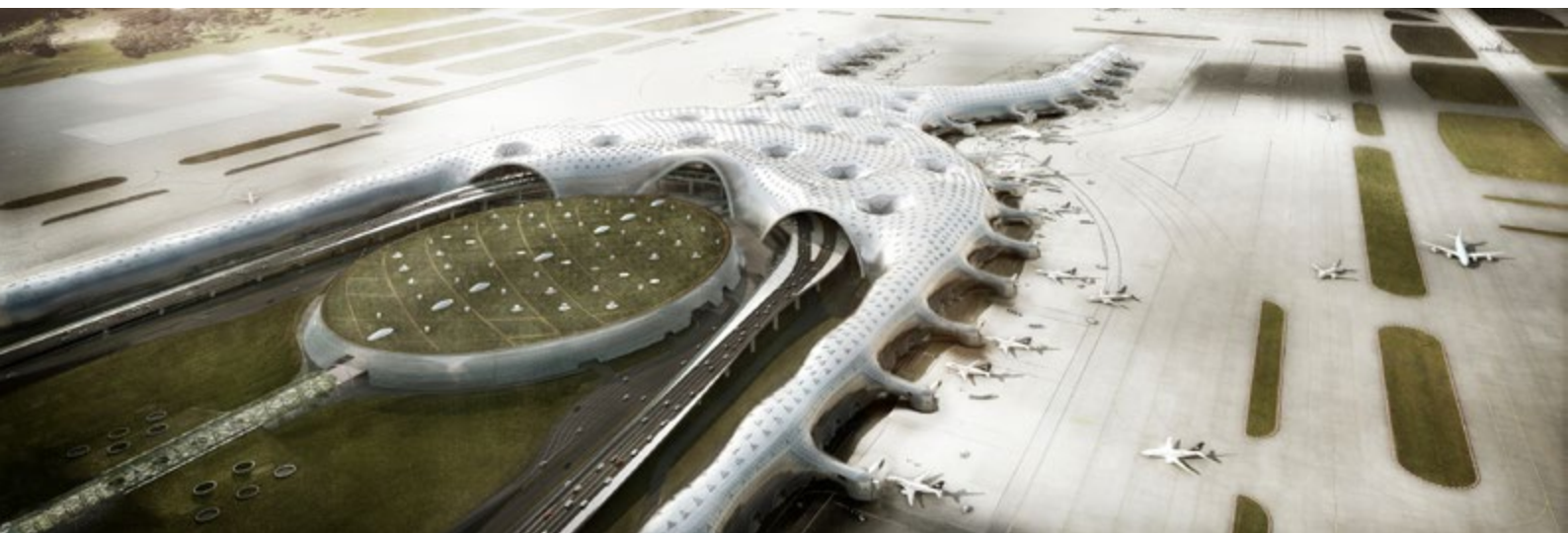

Left top to bottom:

Chateau Margaux, Bordeaux,
France.

Narbo Via, Narbonne, France.

Apple Store Regent Street,
London, UK.

New International Airport
Mexico City, Mexico City,
Mexico.

Apple Union Square

San Francisco, USA 2014–2016

The opening of Apple Union Square in San Francisco marks an important step in Apple's continuous evolution, its purpose and its role in the local community to bring a richer experience beyond opportunistic retail. Its innovative design enables new levels of transparency, openness and civic generosity, incorporating Apple's new features and services. Apple Union Square will be a model for future projects worldwide.

The Apple Union Square introduces five new features. 'The Avenue' is a specially designed area for the display of accessories incorporated into the central spine wall. The 'Forum', a new learning environment, where specialists from various fields come to entertain, inspire and teach, will occupy a prime central position on the mezzanine against a vast video wall which will also act as an animated backdrop for Union Square beyond. To the rear of the Forum is the 'Genius Grove' with a more relaxed setting amongst a small grove of trees, each within a single planter that doubles as a comfortable place to sit and rest while an Apple Genius answers any questions. The unique design of the tree planters was a collaboration between Foster + Partners and Apple's Industrial Design Studio.

The 'Boardroom' – a place for meetings, conversations and partnerships for local entrepreneurs and enterprises is discreetly placed behind the green wall.

Client
Apple Inc.

Services
Architecture
Structural Engineering
Environmental Engineering





The entire building is quietly supported by a giant steel truss structure that bridges over the neighbouring hotel basement ballroom. In turn, this supports further trusses that create the tapered ceiling shape and integrate the network of services throughout the building. Vertical bracing is neatly tucked away inside the spine and side-walls.

Seismic engineering design principles guided every aspect of the structural design, setting the standard for innovation and performance. The generous 40ft high (12m) volume is divided horizontally by a dramatic cantilevered mezzanine floor which tapers to less than 1ft (30cm) and extends 32ft (10m) from the rear wall to create a 16ft high (4.9m) piano nobile. The extremely slim column-free floor structure is made possible by tuned mass dampers to eliminate vibration. The impression is of a floating

stage in the centre of the space in dialogue with Union Square, creating a spectacular living room for the city.

Apple Union Square has won the SEAONC (The Structural Engineering Association of Northern California) Excellence Structural Engineering Award of Merit in the category of Landmark Structures. It has also been shortlisted for the 2017 IStructE (Institution of Structural Engineers) Award in the 'Structural Transformation' category.

Structural section.

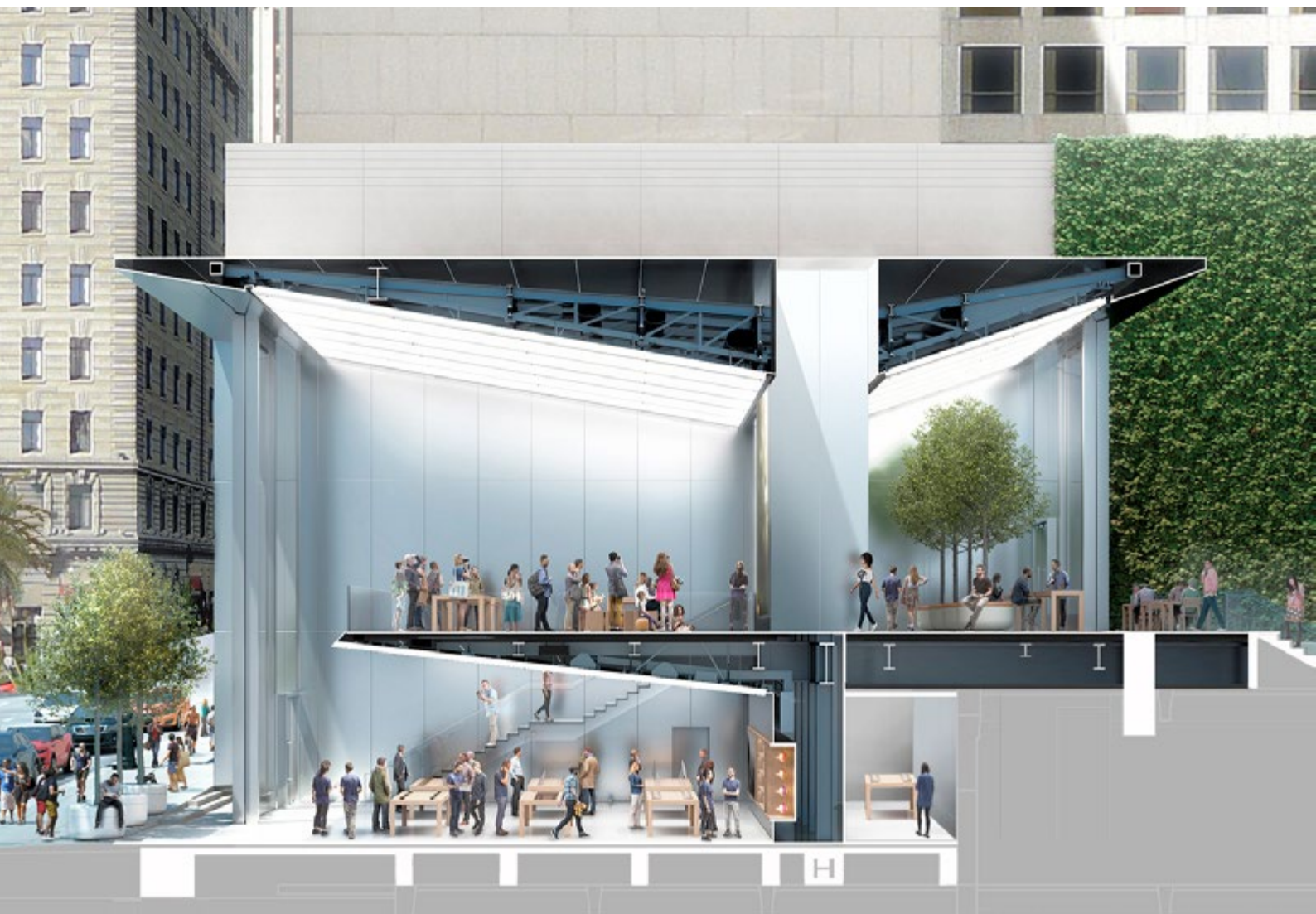

Below: Structural concept sketch.
Apple Union Square exterior.
Structural 3D diagram.

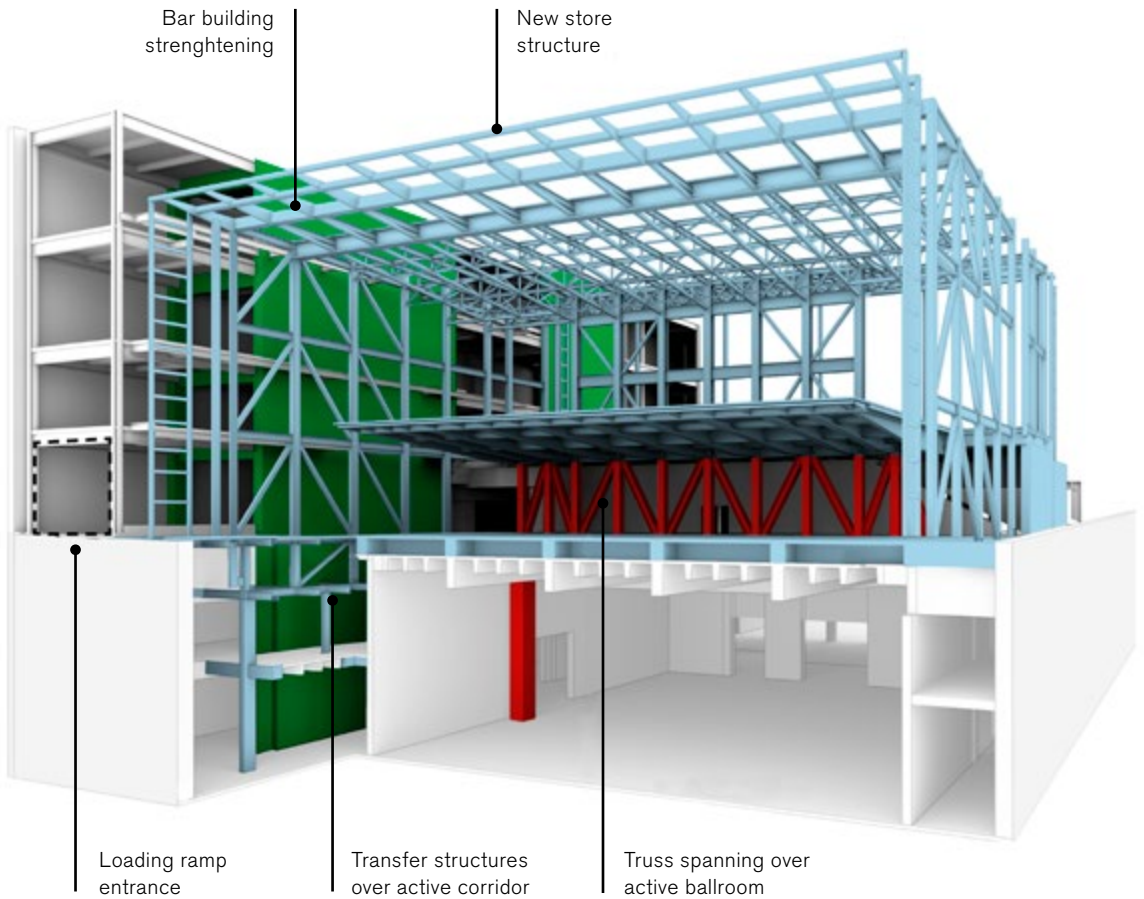
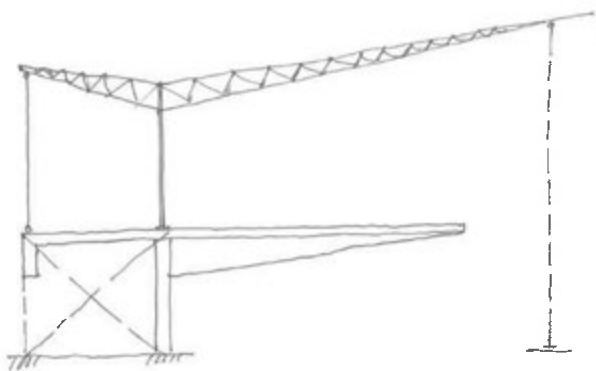

Oceanwide Center

San Francisco, USA, 2013 – 2021

Situated in the rapidly changing Transbay Area of San Francisco, close to Market St and the financial district, the Oceanwide Center development comprises two mixed-use towers, along with impressive new public spaces and important new pedestrian connections. The Oceanwide Center will provide 1.35 million sq ft (125,420m²) of office space and 650,000 sq ft (60,390m²) of residential units. The 850ft (260m) First Street Tower will bring office and luxury condominiums to the market above a new public square, while the 605ft (185m) Mission Street Tower will provide a 5-star 170-key hotel and condominiums. The design will also restore and revitalise two historic buildings on site and will provide a significant amount of new hotel, office and residential spaces in this downtown neighbourhood.

Responsive in urban and environmental terms, the development brings together places to live and work with the city's most important new transport hub, further evolving a sustainable model of high density, mixed-use development that the practice has always promoted.

This development forms part of a rezoning plan, which was put in place to encourage density around the Transbay Terminal, and represents the last mixed-use development of this scale in the area. At ground level, the buildings are open, accessible and transparent – and have been 'lifted up' to provide a new 'urban room' for the region, with pedestrian routes through the site that will knit the new scheme

with the urban grain of the city, providing a connection from the new Transbay Terminal Building to the historic City Center. The project will have a wide ranging programme of art installations throughout the public spaces, along with landscaping by Kathryn Gustafson.

With an offset service cores, the First Street Tower will deliver innovative open plan office floor plates, allowing tenants a high degree of flexibility. Their open layout is supported by an emblematic orthogonal structural system developed for seismic stability, resulting in a structurally rigid, but lightweight structure.

Mission Street Tower has targeted LEED Gold, with the First Street Tower designed to attain a LEED Platinum rating.

Client

Oceanwide Holdings Ltd.

Site Area

52,000 sq ft (4,830m²)

Total floor area

2,000,000 sq ft (185,800m²)

Building Height

Mission Street Tower: 55 Levels

First Street Tower: 63 Levels

Services

Architecture

Structural Engineering

(Conceptual Design)

Environmental Engineering





The structural design conforms to the 2013 San Francisco Building Code, and follows a Performance-Based Design approach using state-of-the-art methodology. Foster + Partners carried out the competition and concept design for the tower. The Engineer of Record is MKA.

The architectural form of the tower was driven by project constraints and program objectives, including the irregular site plan, the mixed use occupancy, the Jessie Street passage, the Urban Room, the desire for open office floor plates, taper and shadow study requirements, and the seismic performance targets. The resulting structural design was generated in response to these project-specific requirements.

The First Street Tower is a primarily steel-framed building with two L-shaped braced frames and perimeter steel bracing. The L-shaped cores are spread apart and positioned toward the west side of the site, making space for an “Urban Room” at the base of the building fronting First Street. The perimeter of the tower is diagonally-braced. The First Street Tower is classified as a Category III structure, and as such must be designed to an enhanced performance level above that required of a typical Category II structure.

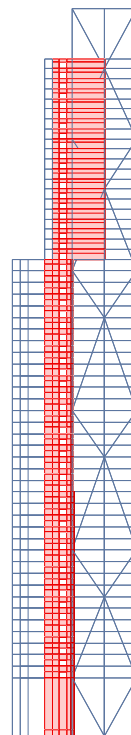

Structural analysis model, undeformed shape.

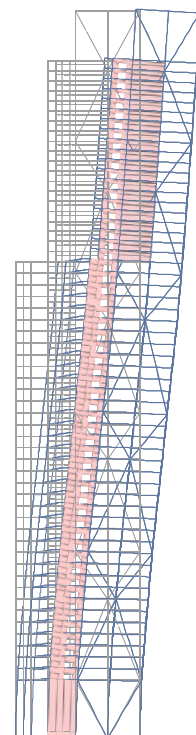

Structural analysis model, deformed shape (x4)

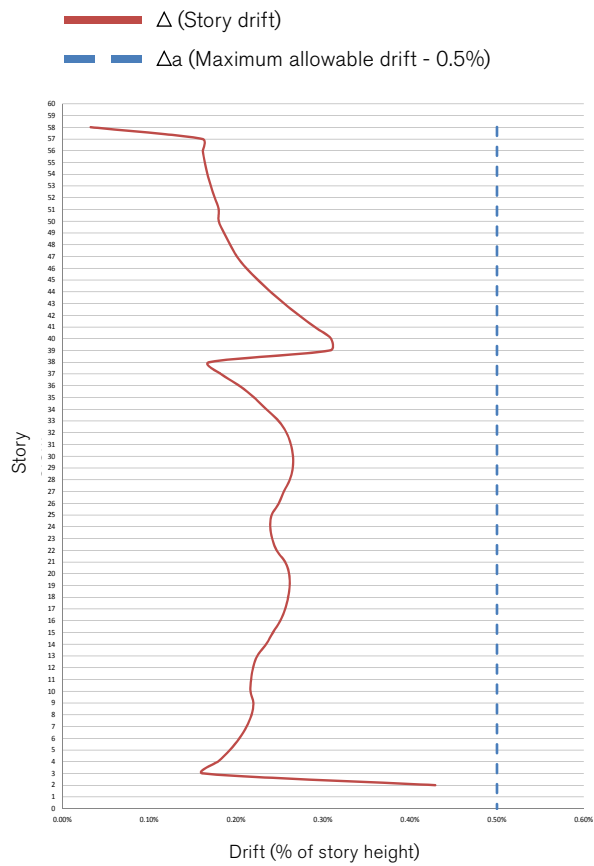

Story drift - X direction

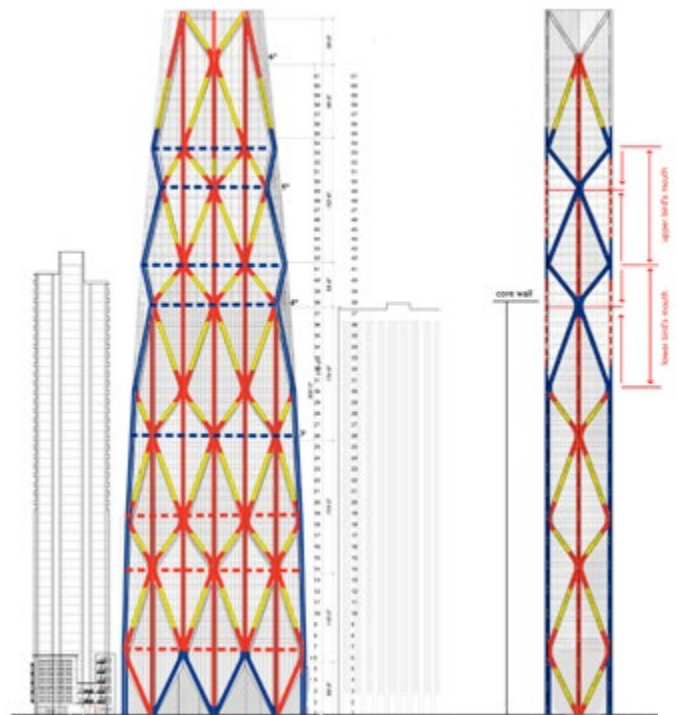

- Critical force-controlled element, unprotected by fuse elements
- Critical force-controlled element, protected by fuse elements
- Critical deformation-controlled element

Apple Dubai Mall

Dubai, UAE 2014 – 2017

Apple Dubai Mall reinvents the traditional introverted idea of mall-based retail as a more outward looking experience that engages with the spectacle of urban life. Its design is a highly innovative response to the culture and climate of the Emirates, while also demonstrating Apple's pioneering ambition to create inspirational civic spaces for all.

Located in Dubai Mall – one of the most visited urban centres in the world, attracting over 80 million visitors every year since 2014 – the new Apple Dubai Mall occupies the most pivotal position in the city, alongside the iconic Burj Khalifa and overlooking the famous Dubai Fountains. Spanning over two floors, it embraces the theatre of the fountains with a sweeping 186-foot (56.6 metre) wide and 18-foot (5.5 metre) deep terrace – a first for any Apple Store – with unparalleled views of the spectacular setting and the incredible choreographed display.

The design of Apple Dubai Mall is a celebration of the sun, using the abundant daylight to create a special ambience within. Reinterpreting the traditional Arabic Mashrabiya, innovative, 'Solar Wings' gently shade the outside terrace during the day and open majestically during the evening to reveal the 'best seat in the house' with a breathtaking view of the waterside promenade and fountains. With their movement path inspired by a falcon spreading its wings, the 'Solar Wings' are in itself a theatrical experience – an integrated vision of kinetic art and engineering. The wings have been

carefully crafted to inspire delight, a delicate combination of form and function.

Made entirely of lightweight carbon fibre, each wing has multiple layers of tubes forming a dense net. Following an in-depth study of sun angles, the rods have been distributed in higher concentration where the solar radiation is the most intense over the year. The unique pattern allows clear views out for people standing on both levels of the store, and the sunlight streaming through the wings casts dappled shadows deep into the interior. The new shaded terrace features nine substantial trees within large planters incorporating seating for visitors to sit, relax and enjoy the view. The planters will rotate mechanically to ensure that the trees receive even sunlight.

Access to the store is through full height, glazed pivoting doors on both levels, directly from Dubai Mall. The Avenue, a specially designed area for accessories display, on the lower level along with Apple's signature display tables sits in the midst of a grove of trees, creating a calm environment to experience Apple's latest products. Apple Dubai Mall will also launch Apple's new global in-store experience, 'Today at Apple' – where New Creative Pros, the liberal arts counterpart of Apple's technical Geniuses, will offer individual advice and training on photography, filmmaking, art and design and more.

Client

Apple Inc.

Site Area

1,505m²

Services

Architecture

Structural Engineering

Environmental Engineering



To realise the vision for Apple Dubai Mall, structural modifications and additions to the existing balconies were required.

The main challenge for the new structure was the construction of a new 10m cantilever balcony at the second level, which forms the ceiling to the store and the external terrace. The cantilever balcony also forms a small terrace for the tenant above, and supports a new shading screen.

This cantilever floor stands at the interface with several key elements of the store, such as the monumental glazed façade and full-height glazed pivoting doors. In addition, the cantilever floor supports part of the mechanisms powering the kinetic solar wings; in particular, the wings are partially hung from this floor. These elements are

inherently sensitive to movements and deflections. Detailed nonlinear analyses were carried out to design the cantilever beams and connections such that deflections were tightly controlled.

This ambitious structure was finally achieved using post-tensioned bars to connect stiff steel built-up nodes to the existing reinforced concrete structure, effectively clamping the new steel cantilever beams to the face of the existing concrete. The existing concrete structure was further strengthened with the addition of a reinforced concrete back span to the new steel cantilevers.

3D model of the new structural steel and existing concrete structure.

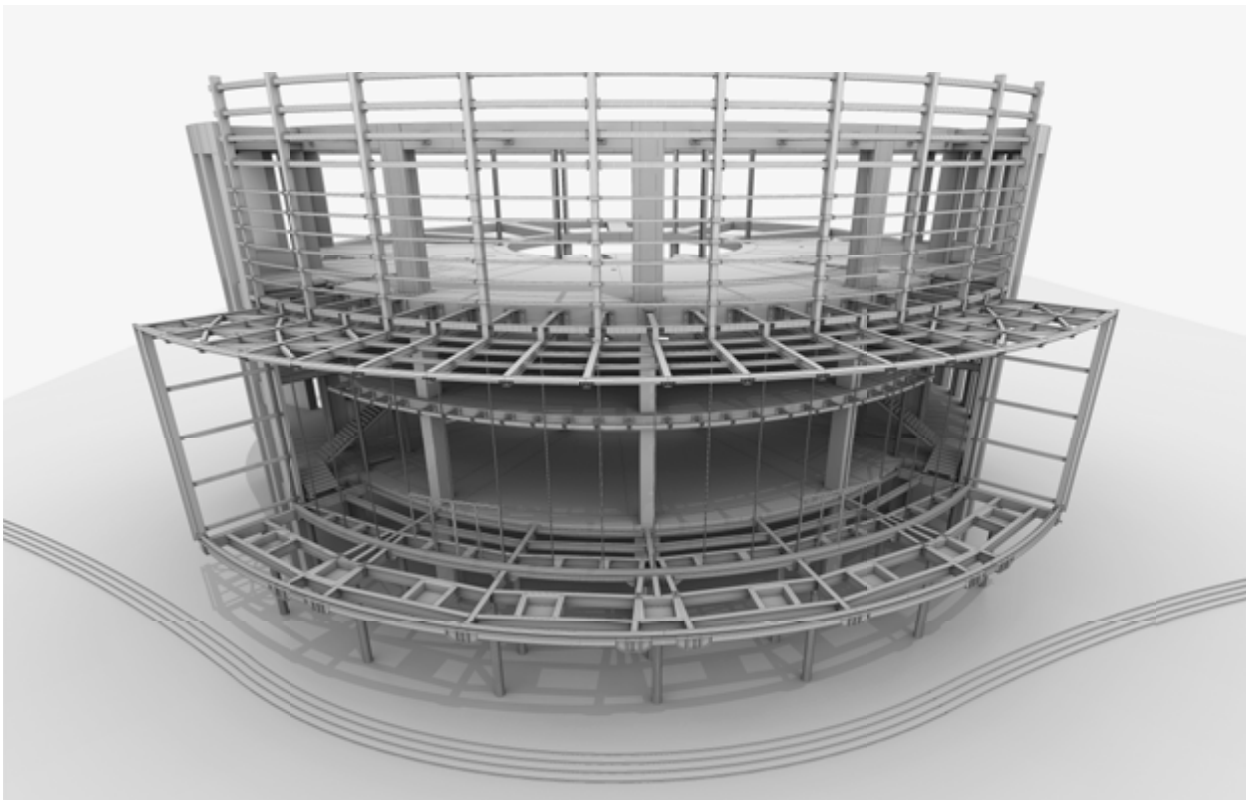

Top left: Steel connections to the existing reinforced concrete beam.

Top right: Underside of the cantilever balcony during glass façade construction.

Bottom: Structural analysis (vertical deflection) and 3d model visualisation of a cantilever node connection to the existing reinforced concrete beam.

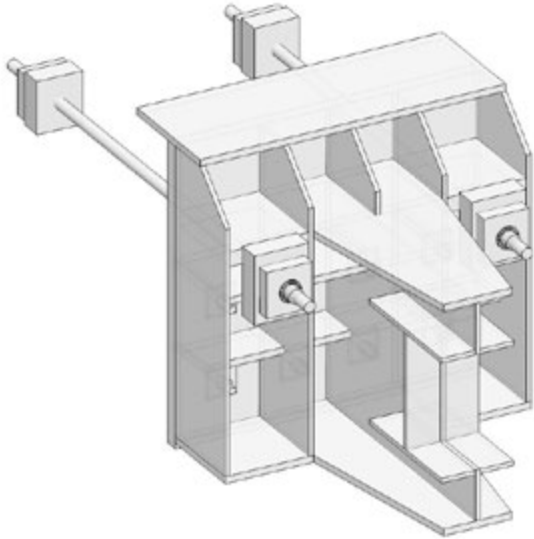
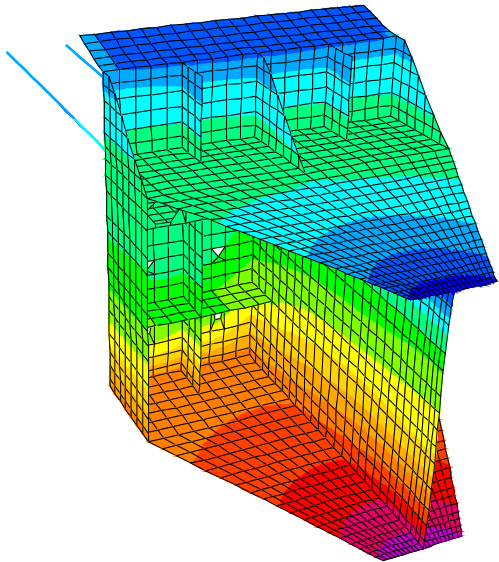
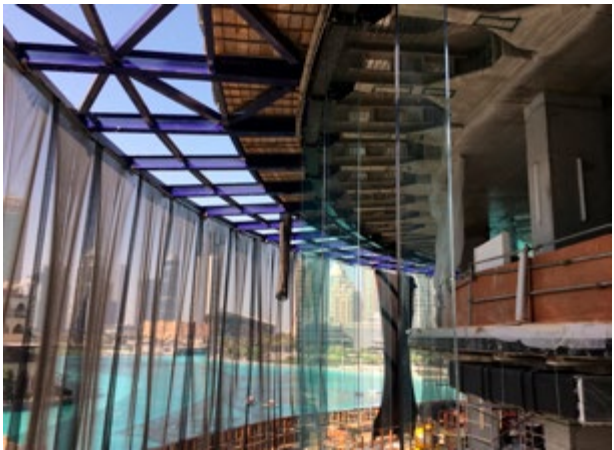

UAE Pavilion, Milan Expo 2015

Milan, Italy 2013 – 2015

The national pavilion for the United Arab Emirates occupies a large site close to the centre of the Milan Expo and is accessed via its main circulation axis, the decumanus. From here, visitors are drawn into the mouth of a canyon-like space, defined by two undulating 12m tall walls. Influenced by ancient planning principles, the pavilion's interior evokes the narrow pedestrian streets and courtyards of the traditional desert city, and its contemporary reinterpretation in the sustainable Masdar masterplan. The high walls continue through the 140m site in a series of parallel waves, unifying the visitor spaces within a dynamic formal language designed to convey the ridges and texture of sand dunes.

A ramp leads gently upwards from the entrance towards the auditorium. Along this route, the irrigation aqueducts that have historically supported agriculture in the region are introduced in digital form. The path leads to a state-of-the-art auditorium, contained within a drum at the heart of the site. After the screening, visitors follow a route through further interactive displays and digital talks, including a special exhibit celebrating Dubai as host city for the 2020 Expo. The pavilion responds to the Milan Expo's theme of 'feeding the planet' by integrating a variety of dining options around the theme of modern Emirati food. The exhibition trail culminates in a green oasis leading into a ground level café, with a formal restaurant on the first floor and a hospitality roof terrace on top.

Conveying a unique sense of place, the landscaping around the pavilion is designed to evoke the UAE's terrain and flora, while the texture of the walls derives from a scan of dunes and represents the different shades of sand across the Emirates. The design targeted LEED 'Platinum' through a combination of passive principles and active techniques, from capturing rainwater on the roof garden to integrating photovoltaic cells. Most significantly, the building is designed to be recycled. The GRC wall panels are supported by a steel frame, which was easily demounted and reconstructed for the pavilion's eventual relocation in the UAE.

Client

National Media Council

Site Area

5,000m² Gross

Exhibition Area

1175m²

Services

Architecture

Structural Engineering

Environmental Engineering





The structural challenge for the Pavilion was to conceive a structure that can be quickly and easily constructed for the Pavilion in Milan, then dismantled and moved to the United Arab Emirates.

The structural conditions of each country are different – while both are seismic, the demand in Abu Dhabi is higher than in Milan – and the geotechnical conditions also vary between the two areas. In order to optimise the re-usability and efficiency of the structure, it was decided to design foundations specific to each region, and to design the superstructure for the conditions of both regions.

The Pavilion is modular in its approach, whilst nevertheless achieving the architectural aspiration of sinuous and continuous curves throughout the building. The prefabricated concrete floors are supported on a steel superstructure, with different stability systems for the various zones to take account of the spatial requirements, whilst resisting the substantial lateral loads.

Right: Construction of the structure. The wall panels are supported by the steel frame.

Below: Visitors follow the route through further interactive displays and digital talks, including a special exhibit celebrating Dubai as host city for the 2020 Expo.





425 Park Avenue

New York, USA, 2012–2018

Following a high-profile international competition lasting for six months, the practice was appointed to design the first full-block office building on Park Avenue for 50 years. The new tower at 425 Park Avenue, which will stand alongside Modernist icons by Mies van der Rohe, Eero Saarinen and Philip Johnson, is conceived as a flexible, enduring new addition to one of New York City's most celebrated streets.

Developed during the competition by the Foster + Partners' integrated design team of architects and engineers, the towers' form is a pure expression of its function. The building is divided vertically into three distinct volumes: a seven-storey base, knitted with the urban grain at street level; a recessed central section; and a slender column of premium offices at the top. These proportions were established through a process of detailed analysis, involving modelling views of Central Park from the site and finding the ideal distribution of areas to achieve a balanced composition. The first set back – a characteristic feature of high-rise design in New York – corresponds with the datum of the street. The second set back develops this theme, physically and symbolically setting the upper levels apart from the rest of the city's office towers. To maximise the Park Avenue frontage, the core is placed to the rear, where glazed stairwells bring life to the eastern elevation and reveal long views towards the East River. Clearly expressing the structure, the tapered steel-frame tower rises to meet three shear walls – extending from the top of the tower, these three blades will provide an elegant marker on the skyline.

Between each volume, the office floors are intersected by dramatic triple-height sky gardens. Offering the prized amenity of open space in the heart of Manhattan, with bars, cafes, facilities for meetings and conferences, the 42-foot-high levels function as urban squares in a vertical city – they will also provide a magnificent setting for gala events. The gardens are defined by a horizontal grid of louvres and sheltered from the wind by a discreet band of glazing. The rectilinear spaces are then bounded by diagonal columns, exposing the structure to emphasise the vast scale of the enclosure. The social focus of the tower continues at street level, where entrance is via a dramatic triple-height atrium and a large public plaza, with the potential for large-scale works of art.

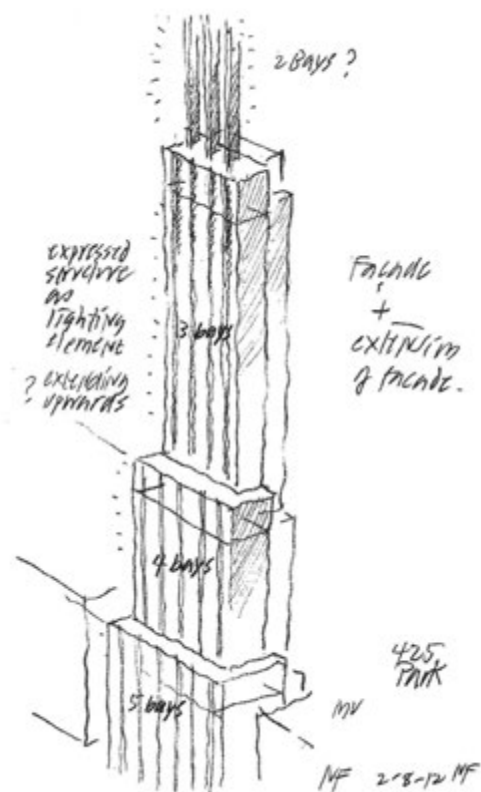

Client

L&L Holding Company and
Lehman Brothers Holdings
Inc.

Site Area

27,940 sq ft (2,595m²)

Total floor area

560,000 sq ft (52,025m²)

Building Height

31 Floors
855ft/260m to top of
structure

Services

Architecture
Structural Engineering
(Competition)
Environmental Engineering
(Competition)



The structural concept for the 425 Park Avenue tower arose from the analysis of the project brief and the desire to provide extraordinary office spaces over the full height of the tower.

The cores are set back from the centre to provide deep flexible spaces, and to define the public ground plane. The city's planning requirements define a series of setbacks from Park Avenue. The structure simply connects the resulting volumes, providing both vertical and lateral support in a single system.

Columns along the front elevation support the front of the floor slabs vertically. As they descend from the top level, they reach the first change in volume, where they bifurcate and connect to the core. They bifurcate once more at the second

change in volume. These two connections coupled with the rear cores provide all of the vertical and lateral support to the building. There is no need for hidden trusses or outriggers, the entire structure is a clear manifestation of the building volume.

Foster + Partners provided the structural concept and competition design.

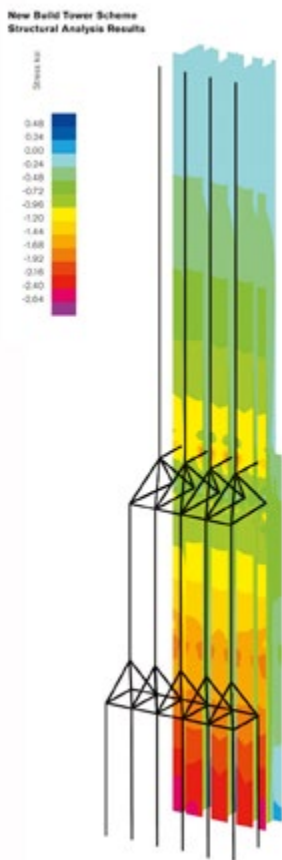

Structural analysis model showing axial stress in the core walls.

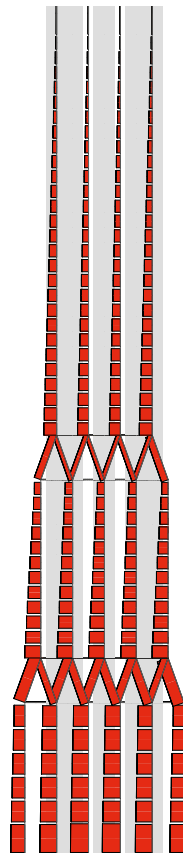

Structural analysis model showing axial force in front elevation.

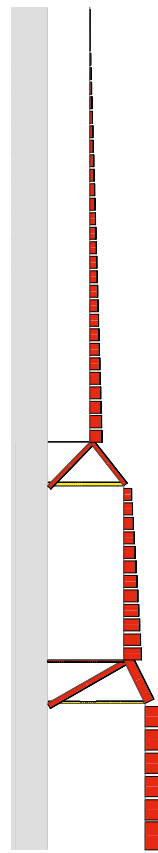

Structural analysis model showing axial force in side elevation.

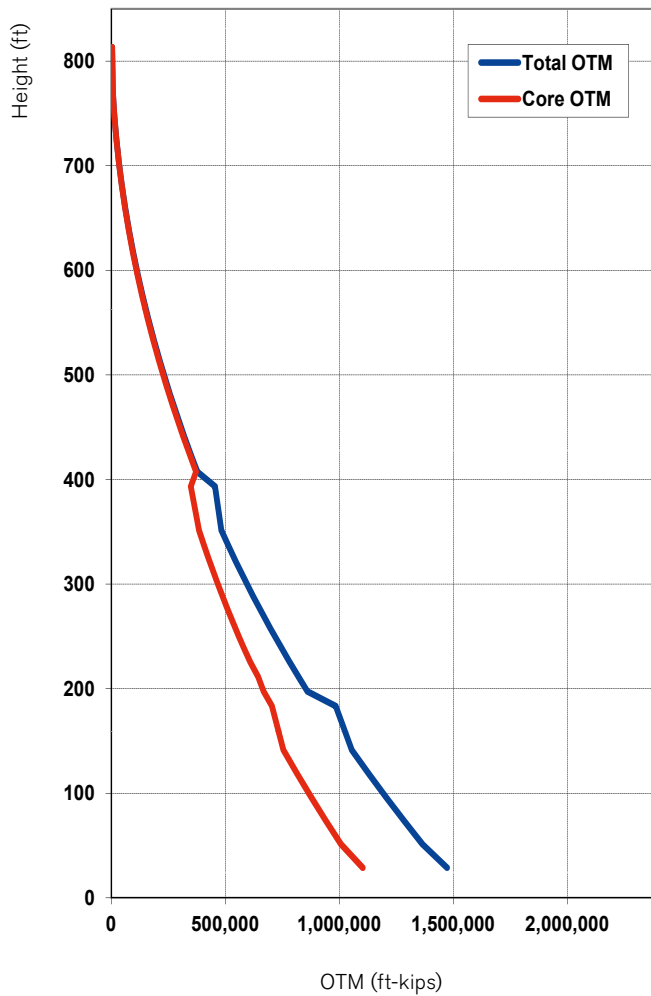

Developed during the competition by the Foster + Partners' integrated design team of architects and engineers, the towers' form is a pure expression of its function.

Apple Zorlu Centre

Istanbul, Turkey 2012–2014

The Apple Store in Istanbul's new Zorlu Centre has been designed in collaboration with Apple and it is the first in a series of new stores around the world. The project is also the first building to be completed by the practice in Turkey.

The store is crowned by a spectacular illuminated glass lantern set in a reflecting pool of water – this provides the jewel-like centrepiece of the shopping centre's crescent plan and acts as a light well, drawing daylight deep into the subterranean retail levels.

The lantern is a deceptively simple, yet technically advanced composition of four rectangular glass panes, each ten metres long, held together without mechanical fixings or visible joins, and covered by a lightweight sheet of opaque carbon fibre.

Below ground, the store is arranged over two levels and features Apple's signature wooden tables, genius bar and stainless steel walls, which have been adopted as the standard for all of the firm's retail spaces. The floors are connected by a pair of dramatic glass staircases, which are positioned beneath two skylights and supported by glazed walls. Daylight is carefully orchestrated throughout, as light is cast through the transparent stairs and store façade, and reflected internally by stainless steel surfaces. The storefront is constructed using nine-metre tall monolithic glass panes which, like the lantern, have no structural fins.

Working alongside one another as an integrated team of designers, architects and engineers, the project has showcased intense innovation in the use of materials and bespoke elements. The luminous ceiling panels, for example, were developed especially for the stores in conjunction with the manufacturers and emit a calm, seamless, even glow. The panels, the largest of which is 27m long, conceal acoustic absorbency and to maximise flexibility, can also be easily lowered to allow access to the ceiling above. The result of close collaboration between architect and client, the store is both an expression of Apple's brand and a beacon for the Zorlu development, with the architecture complementing the purity of form, innovation and ease of use of the products on display.

Client
Apple Inc.

Services
Architecture
Structural Engineering
Environmental Engineering

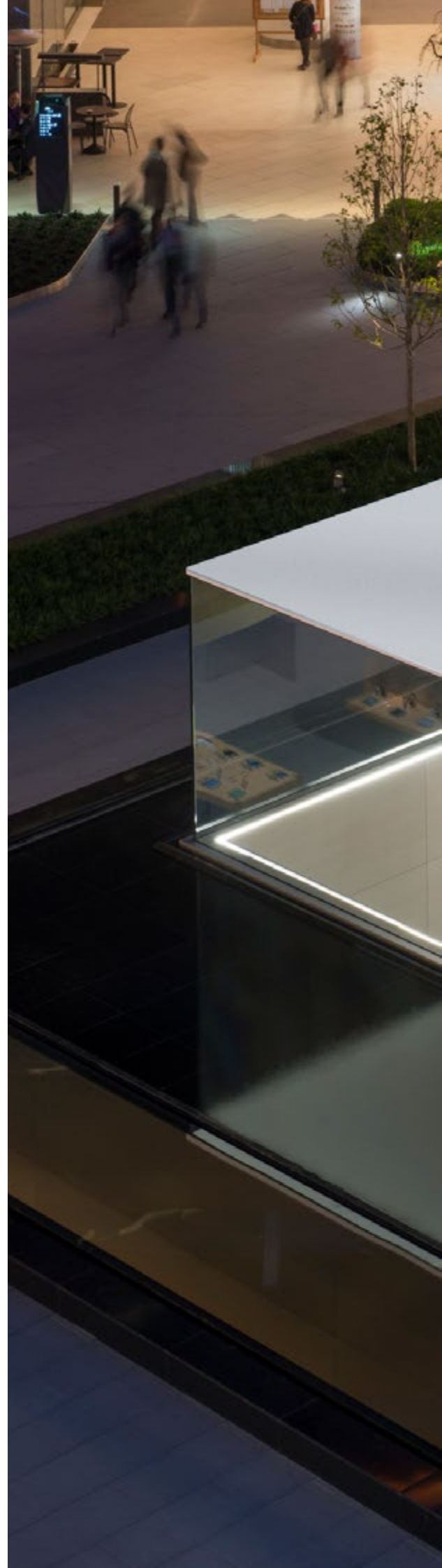



This store is located within the upper two storeys of a subterranean shopping mall in a space that was formally occupied by an open atrium. Significant alterations were required to re-configure the structure to suit the design.

This involved the replacement of the immediate structure surrounding the former atrium at two storeys and the construction of a new mezzanine structure which forms the store's upper floor.

One of the major alterations involved the reduction in depth of two deep primary beams that span 28m over the store space. The original beams were 1800mm deep and retention of these beams would have resulted in an unacceptable headroom height within the upper storey of the store. An increased soffit height of 450mm was achieved through a combination of raising the beam up into the external finishes zone and reducing the beam depth by modifying the bottom flange.

It was essential for the scheme that the new mezzanine floor be structurally disconnected from the surrounding floor structure to provide a visual separation between the mall and the store. Access to the mezzanine is made by two glass staircases that connect down to the lower level of the store. There is also a glass bridge that spans the void between the mezzanine and the mall floor.

To achieve the separation the mezzanine floor is supported on new vertical structure which consists of two rows of closely spaced columns on either side of the floor and four tower structures surrounding the service cores at each corner of the store. The row of columns form a Vierendeel truss which provides lateral stability to resist seismic forces in the longitudinal

direction. In the transverse direction, stability is provided by two portal frames formed by fixing two of the floor beams to deep columns contained within the corner towers. The new vertical structure is supported below the store on new transfer structures that take the loads through several levels of car parking down to the foundations.

It was also important to make the new 16m span mezzanine floorplate as thin as possible. An overall structural floor depth of 500mm was achieved by providing 500mm deep plate girder I-beams at 1.5m centres with a 130mm composite floor supported on joists – all within the depth of the beams. This floor structure was tightly integrated with the architecture and building services to provide an overall floor depth of 800mm. The floor was analysed for footfall-induced vibrations to check that the predicted accelerations would be within normal limits for shopping malls.

The store is surrounded on all four sides by a 10m high finless glass façade. On two elevations the glass wall also provides support to the glass treads that form the staircases. Over the top of the store sits a 9m x 9m lantern consisting of glass walls and a white carbon fibre reinforced plastic roof. The internal walls are clad in stainless steel panels and the floors are covered in terrazzo finishes. The team produced reports to communicate the predicted movements of the building structure due to seismic and gravity loads which were then used in the design of these fit-out elements.



Left: Integrated lighting panels in situ in the open Store.

Right above: Store in Natural Ventilation mode.

Right below: Rooftop integrated Photovoltaic panels (PVs).

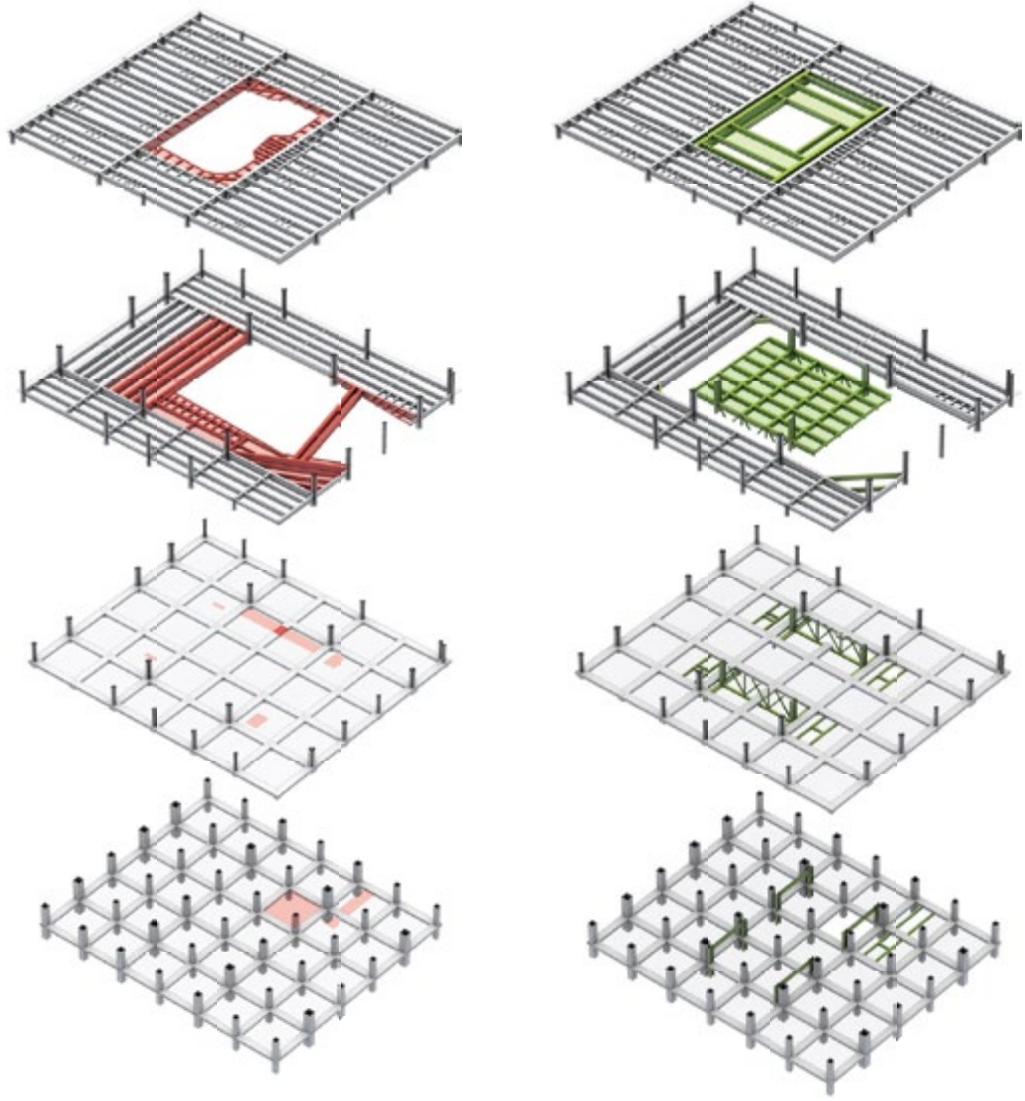

Cleveland Clinic Health Education Campus

Ohio, USA 2015 – 2019

Following our development of a strategic Masterplan for the Cleveland Clinic's 168-acre campus, Foster + Partners was commissioned by the Clinic, together with Case Western Reserve University, to design a new Health Education Campus that looks to the future of integrated and interactive health education. The brief identified an area of our masterplan, close to the Clinic, that could be developed into a dedicated campus, combining two Schools of Medicine, a Dental School and a School of Nursing.

With universities often being at the frontline of cutting edge research, the buildings that house them have to be flexible enough to accommodate emerging lines of scientific enquiry and newer technologies. The growing interdisciplinary nature of research needs informal meeting and debating spaces, and designs that encourage participation in subjects outside of each student's individual curriculum, building a platform for practical learning and testing.

As a response to this, Foster + Partners designed the previously separate four schools as one multi-disciplinary building. Within this, key elements of each school are arranged around an internal central courtyard, maintaining their own identities, but with a layered series of spaces that can be shared to varying degrees. Working closely with the client and consultants we undertook a utilisation study, which identified that if we were to follow the original brief requirements, the rooms would only be utilised an average of 30% of the time. Through understanding teaching methods we were able to amalgamate spaces and increase flexibility to bring this average above 50%, allowing plenty of space for future growth but also giving us the opportunity to reduce the overall area and thus cost of the building. With this approach, the different faculties share teaching spaces, admin areas, lecture halls, recreational areas and even some technical teaching facilities. Each school is now able to share the costs and benefits of better building services, storage and amenities such as cafeterias and personnel support.

The integration of technology and flexibility around future teaching methods was at the heart of our approach. One key example of this was the removal of traditional anatomy facilities, replacing them with fully simulated facilities, including the first use of HoloLens technology in such a context. To achieve this we worked closely with technology specialists and the client to create affordable and workable solutions. The subsequent removal of onerous servicing restraints and the space and money saved have allowed greater investment in future teaching methods, without reducing current teaching capability but rather with the possibility to encompass a far greater number of students connected remotely to the facilities.

Client

Cleveland Clinic,
Case Western Reserve University

Site Area

43,664m²

Services

Architecture
Structural Engineering
Environmental Engineering



The scheme is a courtyard style, education facility, surrounding a large, covered atrium. The 500,000ft² building has four storeys above ground and one level of basement.

The nature of the educational space for the various departments places a high demand on the servicing of the space. The structural solution is therefore sympathetic to these requirements. The floor structure comprises steel beams, profiled composite metal deck and reinforced concrete floor slabs. Concrete filled, circular composite columns are used at the perimeter with standard W-flange sections for the interior columns. The structural bay sizes and beam depths have been tailored to create a constant depth void below the structure for maximum efficiency in services distribution.

The unique feature of the structural design is the courtyard roof that has a span of 150ft (46m). Cleveland experiences harsh winters with regular heavy snow fall. The design requirement is for the skylights to allow daylight to enter the courtyard all year round, despite the snow. This is achieved using 17 V-shaped Warren trusses which are tapered to optimise steel usage. Their section is designed to form a roof profile that sheds snow from the glazed skylights between them. Extensive physical modelling in a sand and water flume has shown that the gutters between truss chords will accumulate snow in the strongest part of the structure whilst the taper assists in sliding snow and melt water to the cores for removal to the rainwater attenuation system. This unique and efficient structure is a result of the multidisciplinary approach taken by the integrated design team.

An additional challenge is the design for footfall vibration in a number of areas of the building. The very long span, cantilever courtyard feature staircases required complex modelling to assess the behaviour under various loading scenarios, resulting in the specification of tuned mass dampers at critical locations. The bridges and cantilevered walkways, as well as the general long span floor areas also required analysis to prove their performance to the strict criteria required by the client.

At the perimeter of the roof, there is a 23ft (7m) elevated cantilevering canopy. The purpose is to provide shading to the façade below and obscure the view of the rooftop plant from the surrounding roads. There are also long span transfer trusses over the lecture halls supporting three floor levels. The foundations comprise shallow pad footings and a 30in (760mm) thick reinforced concrete raft slab under the partial basement. The basement itself had to be designed to resist the buoyancy forces of the relatively high water table. Whilst the permanent gravity load was sufficient to counteract the water pressure, a specific sequence and monitoring regime was put in place during construction.

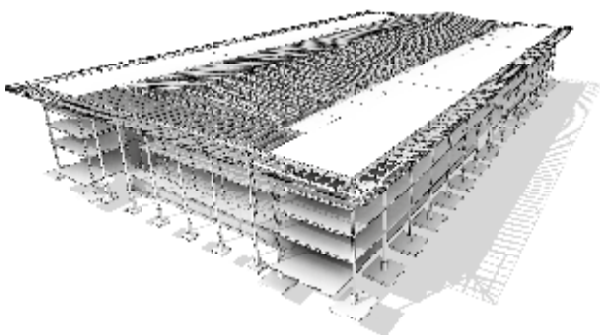

Left: Structural BIM Model
Construction of the courtyard roof.

Below right: Construction of the
courtyard roof.



Apple Westlake

Hangzhou, China 2013 – 2015

Foster + Partners has completed a major new Apple store close to Hangzhou's West Lake, which combines an understanding of the local context with the philosophy of simplicity, beauty and technical innovation that characterises Apple's products. Close collaboration between Apple and Foster + Partners' integrated team of architects and engineers has created the ideal environment to view and interact with Apple's products. Every aspect of the store has been optimised, minimised and de-cluttered. The white ceiling, which appears as an opaque surface during the day, is dramatically illuminated at night – the custom-made lighting panels emit a pure, even glow, as well as absorbing noise. The 15m high volume creates a sense of space and calm within the busy store and city. It is divided horizontally by a dramatic cantilevered floor, which extends 12m from the rear wall like a diving board to create a 9m high piano nobile. The extremely slim floor structure is only made possible by tuned mass dampers to eliminate vibration, and it tapers from 1.2m to just 10cm. This gives the impression of a floating stage in the centre of the space – a new living room for the city.

The miniaturisation of architectural elements demanded the highest levels of technical innovation and integration. The practice's in-house structural and environmental engineers, architects, lighting, acoustic and fire safety teams worked closely with Apple, local partners in China and manufacturers to create a completely streamlined, even ceiling. In addition, the treads of the glass staircases on either side of the space are held in place by a discreet bolt, embedded into the glass to give the impression of floating glass steps – an appearance of effortless simplicity, which belies the complexity of the engineering solution.

Apple has always been at the forefront of technological advances in the use of glass, and the façade comprises 11 large double-glazed panels, each rising 15m. The space is shaded by a series of blinds, which respond to the path of the sun and, when retracted, are concealed within the ceiling.

Client
Apple Inc.

Services
Architecture
Structural Engineering
Environmental Engineering

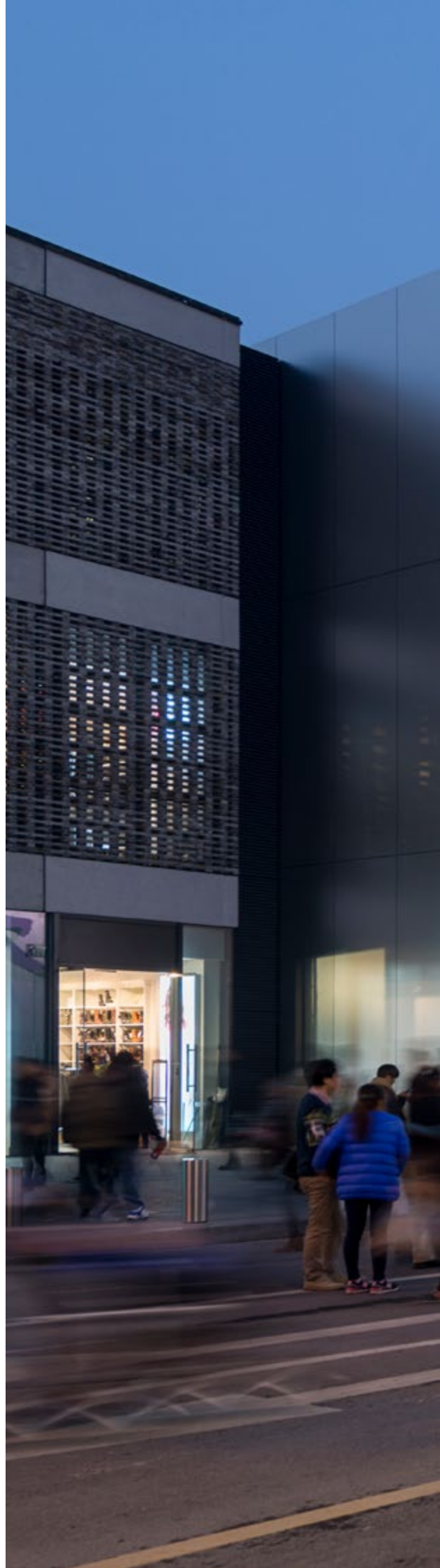



The main feature of this store's structure is the 12m cantilever floor, which creates a large column-free space at the ground floor.

The building has been tightly integrated between structure, services and architecture to achieve an ultra-thin envelope surrounding the fully glazed façade at the storefront.

The structural system consists of a steel frame with composite slabs and metal decking at the roof. Gravity loads are mainly resisted by the two rows of columns in the East-West direction, concealed within display walls. Slender columns on the two sides of the building provide support for the glass staircases and part of the roof; they also form the enclosure for the building envelope and resist wind loads from the external cladding faces.

The cantilever floor is set-back from the side walls on three sides and cantilevers 12m. This is achieved by fabricated plate girders and shallow fabricated steel floor edges; the overall structure of the floor tapers from 1.2m deep to only 10cm at the tip.

The main columns are braced within the display walls in the East-West direction, and form moment frames in conjunction with the floor beams in the other direction. Hangzhou is located in a moderate seismic zone. Due to the unique and irregular nature of the cantilever floor, particular care had to be taken to satisfy the seismic design criteria.

From the start, the project team was conscious that the floor would be susceptible to footfall-induced vibrations – exaggerated in the customer's minds as the floor resembles a diving board. Finite element models were used to predict the dynamic behaviour of the floor. It was found that additional mitigating measures were required to improve the dynamic response of the cantilever floor. Tuned Mass Dampers (TMDs), commonly used in bridges and towers, were specified to dissipate vibration energy and improve the customers' comfort.

The construction team working on the ground floor.

Glass staircase inside the store.

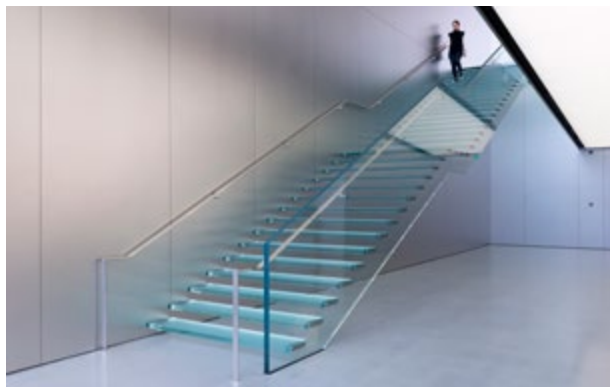

Structural BIM model.
Opening day of Apple Westlake.

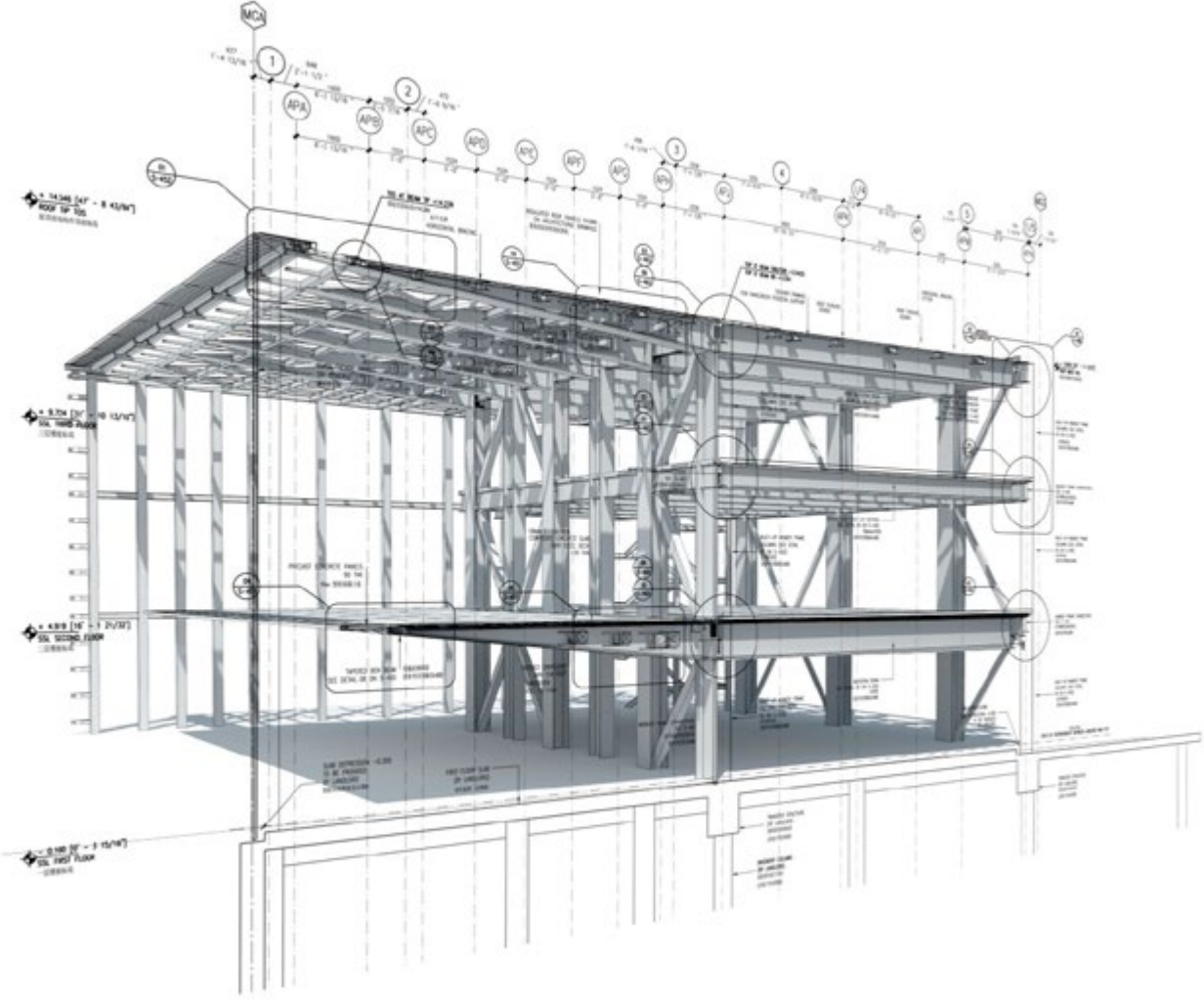

Keruen 2

Astana, Kazakhstan 2014 – 2019

Keruen 2 occupies a 1.3 hectare site in an important location on Astana's main ceremonial axis, close to the 2017 Expo and adjacent to the Keruen 1 shopping centre – the two different retail experiences are linked by an open pedestrian plaza. The design successfully brings together the public and private worlds of the shopping mall and office tower, while making a positive contribution to Astana's urban fabric. The office tower addresses the boulevard, maximising city views and creating a clearly defined street frontage that complements the scale of its neighbours. The horizontal suspended structure is articulated, highlighting the separation between the tower and its base – inside, this structural solution allows for highly flexible, column-free office floor plates. At ground level, an enclosed winter-garden provides a shared entrance to both offices and mall, with its orangery of mature fruit trees and monumental escalator visible through an elegant colonnade.

The shopping centre extends over two storeys, stretching away from the tower. Its roof is laid out as a park, animated by a cinema, entertainment spaces and light wells, which draw sunlight into the heart of the mall. The design is rooted in analysis of Astana's climate and the solar path across the site – placing the tower to the north allows sunlight to reach the roof of the shopping centre, and the glazing of the office levels varies in thickness according to orientation. Where the vertical tower meets the horizontal mall, the space encloses an impressive exhibition venue.

Vehicle drop off for VIP access is located on the main boulevard, and two levels of underground parking are provided, ensuring that in the middle of winter visitors do not have to step outside. Inside the shopping centre, the main circulation route follows a figure of eight formation, intuitively guiding visitors to the anchor stores and courtyard spaces. Unlike the linear arrangement of stores typically found in a conventional shopping centre, the units are staggered and the layout offers a variety of experiences and views. The design encourages exploration, as visitors move from a light-filled courtyard to an elegant arcade.

Rich, tactile materials and details help to create a sense of intimacy and luxury. A sense of order is established by vertical and horizontal fins, which provide both separation between stores and flexibility to support single level and two-storey units.

Client

Capital Partners

Site Area

66,000m²

Services

Architecture

Structural Engineering

Environmental Engineering



The project comprises a fifteen-story office tower and a three-story shopping mall above a two-story deep basement used for underground parking and mechanical plant rooms.

The office tower measures 20m by 76m on plan and has an overall height of approximately 93m above ground. The structure consists of composite slabs supported on steel beams which are in turn supported by steel plate hangers suspended from three lines of two-story deep steel trusses located at mid-height and top of the tower. Each truss zone consists of two perimeter trusses which span between steel mega-columns and concrete shear walls respectively, and an internal truss which spans between core walls. The perimeter truss and hanger support system as well as the mega-columns and shear walls are all visually expressed in the architecture of the office tower. In elevation, the tower is divided into three separate zones: two vertical stacks of floors suspended from trusses and a 17m tall glass box which forms a tree-filled garden lobby on the ground floor. The roof of the garden lobby is also framed in steel and is suspended from the Level 1 floor structure.

The basement, which measures 90m wide by 160m long and 9m deep, consists of reinforced concrete flat slab construction and the entire structure is supported on 800mm diameter piles, which extend 15m below the basement level. Above the ground floor, the superstructure of the shopping mall is also reinforced concrete flat slab but around the large atrium openings, post-tensioned concrete slab is used to allow the structure to cantilever up to 9m with minimum structural depth. This provides a column-free circulation zone around the atriums which optimises the retail experience. Post-tensioned concrete slab is also used to support the heavy landscape and green roof loading on the uppermost levels of the shopping mall. Foster + Partners provided full structural engineering services from concept design all the way to construction documentation.

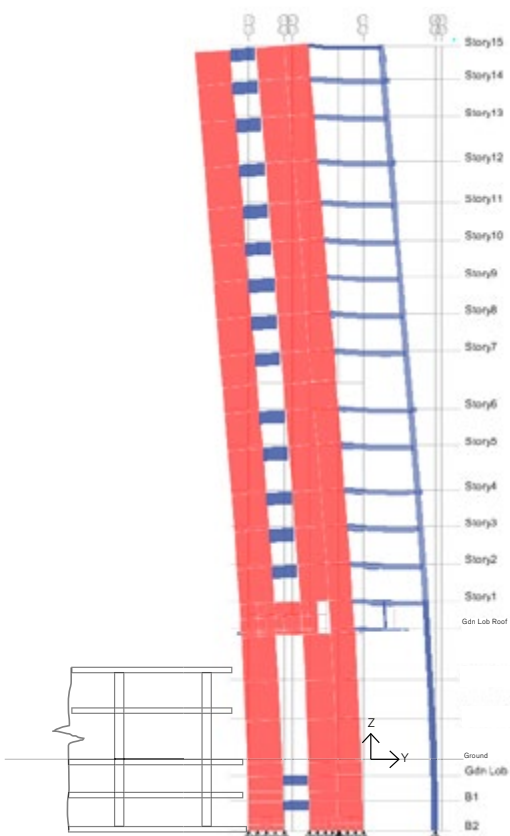

Overturning wind drift diagram

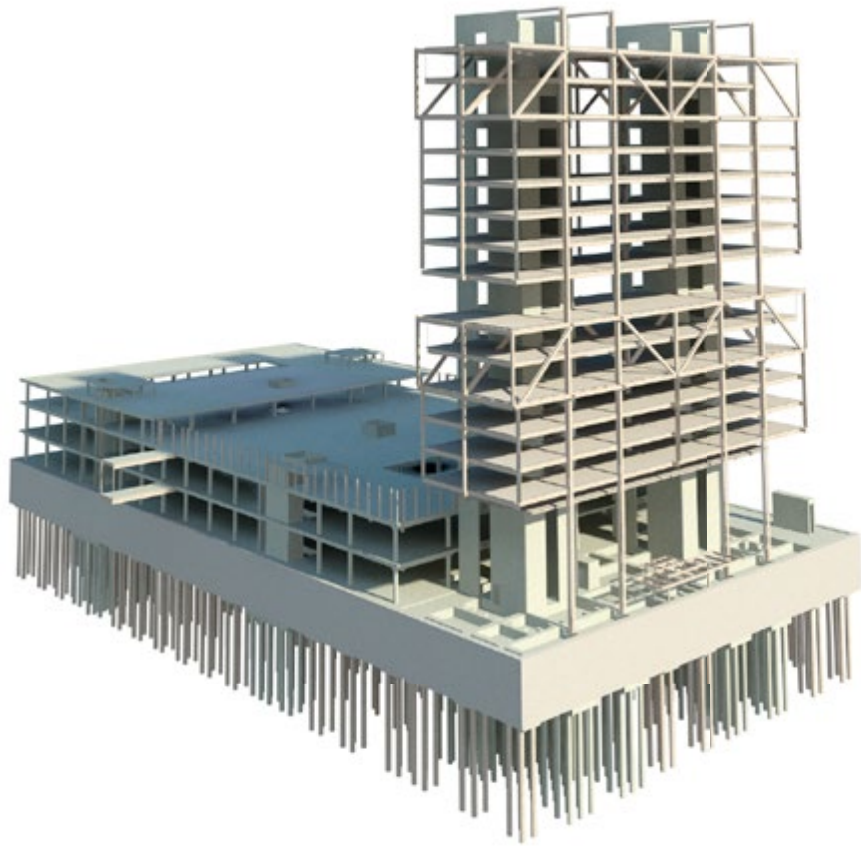

Above: Structural BIM model.
Below: Visualisation of the shopping mall and 15 floor offices.



Apple Regent Street

London, UK 2014 – 2016

The re-imagining of Apple Regent Street in London marks the continuing evolution of Apple, going beyond retail to create richer, more dynamic experiences for visitors. Its innovative design creates a relaxed environment, while incorporating Apple's new features and services. The design is the result of a close collaboration between Apple's teams led by Jonathan Ive, chief design officer and Angela Ahrendts, senior vice president of Retail and Foster + Partners.

Characteristic of the new Apple Flagships, the interior space is a 7.2m double-height grand hall – forming a 'town square' like space that is flexible and welcoming. The design enhances transparency from the street and floods the store with natural light, dramatically improving the visual connection between the two levels. The interior front façade, with its full height arches clad in Portland stone, can be appreciated in its full extent. The store also features the longest Luminous Ceiling Panels in the world that cover the entire ceiling. The custom-made lighting panels emit a pure, even, white light, and have the capability to absorb ambient noise.

Using a warm palette of materials including stone, wood and terrazzo that is sympathetic to the historic nature of the building, the store has a calm setting, with the increased height allowing for the addition of twelve Ficus Ali trees on the ground level, bringing nature to the interior spaces. The grove of trees have planters – designed by Apple's ID Studio and Foster + Partners – that double as a comfortable place to sit and rest. The signature Apple display tables are set against the backdrop of the new

Avenue – the completely redesigned wall display that allows people to touch, feel and try out the Apple products and accessories in an engaging and hands-on way. Located in the middle of the space, The Forum is a new learning environment, where experts from various fields can come to entertain, inspire and teach. It occupies a prime position in the store with a vast video wall that acts as an animated backdrop for the entire store.

Along the side walls, a staircase on either side of the screen draws one up to the new mezzanine level set amongst the treetops. The walls and staircases are made from sandblasted stone, while the balustrade – seemingly carved in to the wall – has a smooth, curved, and honed finish that is pleasant to touch. The stone walls and balustrade were created by a combination of hand craftsmanship and CNC robotics, and were dry assembled at the manufacturing site to make sure each piece fit perfectly before installation.

Overlooking the grand hall, the mezzanine hosts the Apple's Geniuses, where visitors can get assistance to setup their device or answers any product related queries, and the Boardroom – a place for meetings, conversations and partnerships that can be used by app developers, digital entrepreneurs and other small start-ups to become part of the Apple family.

Client
Apple Inc.

Services
Architecture
Environmental Engineering



Tocumen International Airport

Panama City, Panama 2012 – 2018

The masterplan for the expansion of Tocumen International Airport is planned to increase capacity from 5.8 to 18 million passengers a year by 2022, establishing an important new hub for the Americas. The new terminal is designed to reflect the Panamanian landscape, evoking a unique sense of place to welcome visitors to the country and removing the anonymity of the international hub experience for transit passengers.

Two symmetrical wings of piers extend to the east and west from the garden and central concourse, and the entire building is unified beneath an aerodynamic bronze-coloured roof. A warm interior materials palette of stone and exposed beams complements the metallic tones of the roof, and glazed façades open the airport up to the airfield and landscape beyond. As the focus of a hub is on transfer passengers, the terminal's planning minimises connection times, with strong visual connections across the airport to allow intuitive way-finding. Viewed in plan, the curve of the building's façade has been carefully balanced to minimise walking distances, while extending to accommodate a large number of aircraft stands.

Engineering and architecture were conceived together, resulting in a comprehensive environmental strategy that balances complementary active and passive measures. Openings in the roof allow daylight to penetrate the furthest reaches of the building, and a deep overhang protects the glazed façades from solar gain, thus minimising the need for mechanical cooling. Importantly, the structure is designed to enable a fast-track schedule in tropical conditions, and the project is phased to allow the airport to operate during construction.

Client

Odebrecht Panama

Site Area

82,000m² Gross

Services

Architecture

Structural Engineering

Environmental Engineering





The 666m long, 25m tall South Terminal building is divided into 5 zones along its length by 4 seismic joints to mitigate effects arising from thermal expansion and seismic relative displacements.

In addition to dividing the superstructures, the seismic joints also separate the ground slab and the foundation into five independent substructure systems. In each of the three central zones, the structural system comprises a long span lightweight structural steel roof supported on a multi-storey reinforced concrete mezzanine structure having perimeter and interior columns extended to the roof level. In each of the two end zones, the structural steel roof is supported by the perimeter reinforced concrete columns with the mezzanine structure being independent.

The structural system of the roof consists of unfilled metal decking, flange shape secondary beams spanning along the transverse direction and hollow circular shape primary beams spanning along the perimeter direction. The complex roof surface geometry dictates that both the primary and the secondary beams are curved in space. In addition, the architectural expression requires an unconventional roof structural framing system. Along the perimeter, in the longitudinal direction, the primary beams are aligned with the columns. However, along the transverse direction no beams are connected to the columns, thus relying on the torsional stiffness of the hollow circular steel primary beams to enhance the lateral stiffness of the cantilevered reinforced concrete columns.

The Foster + Partners structural engineering team provided a one-stop service from developing the schematic and detail designs to delivering a full set of construction drawings followed by construction administration. The biggest challenge facing the team was to deliver construction documentation to meet the fast track Design & Build project programme, with site construction work commencing only 5 months after the start of the schematic design stage. Construction documents have been successfully delivered to site on a regular weekly or bi-weekly basis to enable continuous site activities.

Panama is located in a region of moderately high seismic hazard. The Tocumen International Airport Authority classifies the South Terminal building as an essential facility and requires a non-conventional structural seismic design approach to protect life as well as to maintain operational continuity. The Foster + Partners structural engineering team adopted state-of-the-art performance-based seismic structural design methodology, including nonlinear static pushover analysis as well as nonlinear response history analysis methods. Our performance based design analyses and calculations, as well as our construction drawings, have been reviewed and approved by internationally recognised experts and two independent peer review teams.

Our structural design was presented at the 2017 Structures Congress of the American Society of Civil Engineers (ASCE) in Denver, CO (USA) and published in the Congress Proceedings. It will also feature in an upcoming Special Publication on Performance-Based Seismic Design of the American Concrete Institute (ACI).

Left: Aerial view of the construction site.

Below: Concrete column fuse detail.

Concrete column to roof edge beam connection with integrated rainage.

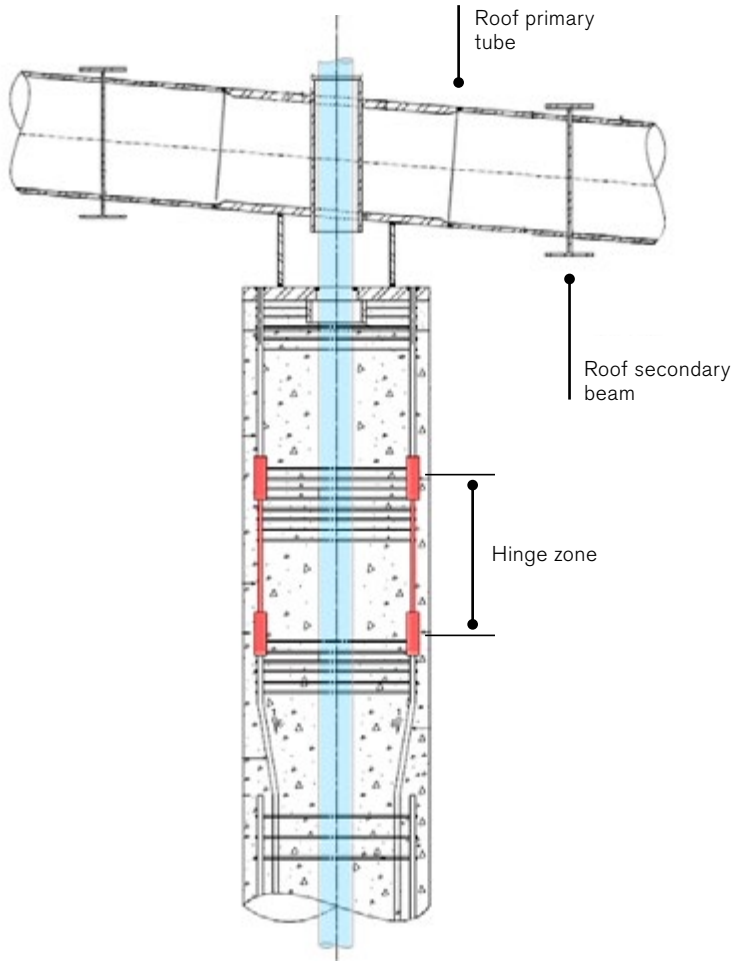





Château Margaux

Bordeaux, France 2009 – 2015

Château Margaux is a Premier Cru and one of the world's leading wine producers. Since it was built in the early 19th century, the Bordeaux estate has evolved to meet changing operational requirements, but no longer had the capacity to adapt to meet future needs. Following a 2009 study, Foster + Partners has been appointed to design the first new construction on the site for 200 years, providing the estate with the flexibility and new facilities that will support its continued quest for excellence. To address the dual challenge of meeting exacting technical requirements, and integrating with the existing collection of buildings, the approach has been holistic.

The original estate was planned as an entire farming village, with the chateau surrounded by all of the industrial facilities needed for wine-making. The design retains this connection between process and architecture. A new building for the production of primarily white wine extends from the eastern wing of the existing winery complex, balancing the overall composition. Its highly flexible, open enclosure is shaped by the different wine-making processes and includes a new research and development centre. In its simplicity, the new building reinterprets the form of the existing industrial facilities and comprises a pitched roof at the same level, supported by tree-shaped load bearing columns and punctuated by light wells.

In addition to new construction, the ensemble of buildings has been restored to their original design intent and the existing winery has been connected to a new underground vinothèque. Located away from the flooding area, this provides safe, environmentally stable underground storage at the heart of the estate. This new facility is linked with the current refectory, which has been refurbished to form a new visitors' centre, welcoming guests as the start and end point for tours of the estate. The historic Orangerie, the oldest structure on the estate, has also been refurbished.

Client

SCA Château Margaux

Site Area

4,850m²

Services

Architecture

Structural Engineering

Environmental Engineering

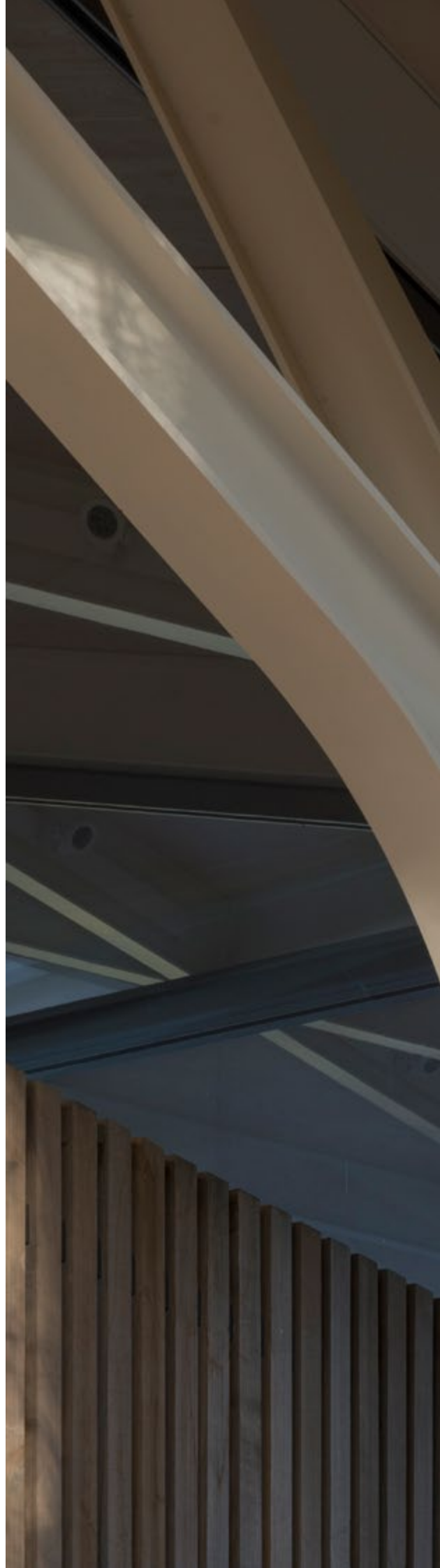



From the exterior the Nouveau Chai building fits into the vernacular of the surrounding farm house buildings with a shallow pitched roof finished with terracotta tiles.

Beneath the traditional tiles, an exposed steel diagrid structure provides the dramatic architectural expression to the internal space. The roof structure of the new Chai spans the 28 metres across the building with a grid of beams that are no deeper than 360mm – three times shallower than would be afforded with a classic beam system. The efficiency of the roof is achieved by using the beam elements in a diagrid, such that they resist the applied loads through compression as well as through bending.

The supporting ‘tree’ structures have been designed to anchor the roof, providing both vertical support, and lateral support to prevent the roof from spreading. It is the trees therefore that provide the critical structural element for the building, and enable a column free zone for the technical requirements of the winery, whilst fitting with the architectural expression of the rest of the estate buildings.

Château Margaux was shortlisted for The 2015 IStructE (Institution of Structural Engineers) Awards in the ‘Commercial or Retail Structures’ category.



Left: Design review of the steel
diagrid and supporting 'tree'
structures.
Right: Structural diagrams.
Below: External view
of Nouveau Chai.

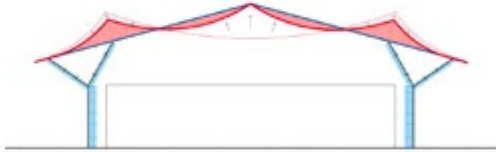
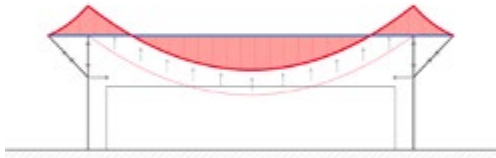
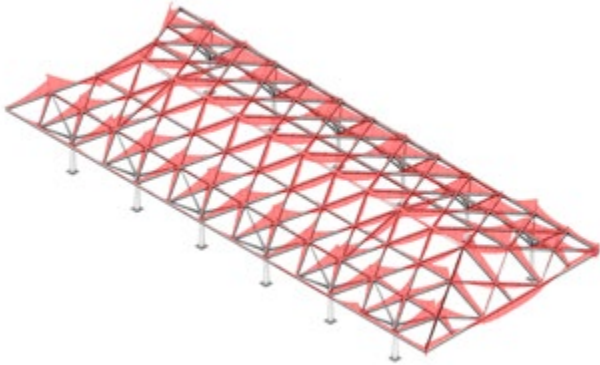
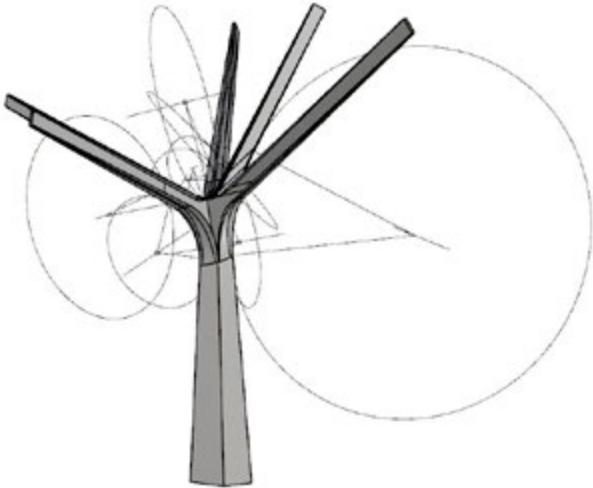

Hongqiao Vantone SunnyWorld Centre

Shanghai, China 2011 – 2017

The Hongqiao Vantone SunnyWorld Centre is a major new sustainable masterplan for a prominent site at the heart of the Shanghai Hongqiao CBD. Forming part of a large-scale urban plan that extends from Shanghai's main station, the dynamic new mixed-use community is centred on a new four-hectare public park. The scheme brings together highly efficient, flexible office buildings, animated at ground level by shops, restaurants and a range of new civic spaces.

Designed to set a new benchmark for sustainable design in the city, the office buildings border the linear park and are oriented to minimise solar gains and maximise views. The buildings are laid out as triangular fingers, which intersect to create visual connections between the ground level and offices above, while drawing greenery deep into the site. Their slender floor plates maximise daylight and natural ventilation, while providing a flexible solution that can easily adapt to future change.



The park culminates in a landmark building, whose scale responds to its location as the 'end point' of the development, while relating successfully to the canal and city quarter beyond. Its distinctive form provides a marker the office campus within the wider masterplan. Designed and engineered by Foster + Partners integrated architectural and engineering design teams, the project establishes an open, interactive workplace, rooted in a sense of place and community.

Client

Vantone Real Estate Co. Ltd
and Sunnyworld Group
Co. Ltd

Services

Architecture
Structural Engineering
Environmental Engineering

Site Area

28,000m²

Total floor area

Office: 60,000m²

Exhibition: 3,000m²

Commercial: 70,000m²



A key feature of the structural system is the composite construction. The floor structural system comprises steel beams, profiled composite metal deck and reinforced concrete floor slabs.

Encased steel reinforced concrete composite construction is selected for the columns. The hybrid steel beam – composite column moment resisting frames and the reinforced concrete core walls form a dual lateral load-resisting system to resist the wind load and the earthquake action.

Movement joints are introduced to separate the Landmark Building to two cylindrical shaped independent structures and to separate the Vantone Centre and the SunnyWorld Centre to six triangular shaped independent structures. The joints are sized to accommodate movements induced by thermal expansion, wind and earthquake actions. Sliding bearings are used at the joints to support the floor beams.

The foundations comprise a 1m thick reinforced concrete raft slab and 800 mm diameter piles ranging from 55m to 70m long.

The unique features of the architectural design have resulted in several horizontal and vertical structural irregularities. These have resulted in the seismic structural design of the three buildings beyond the scope of the Chinese design codes. A performance-based seismic design methodology has been adopted by the Foster + Partners structural design team. The Foster + Partners structural design of all three buildings have passed a rigorous expert panel review and approval process of the Shanghai Municipality.

Landmark building structure and underground conditions.

Finite element model of one of the triangular buildings.

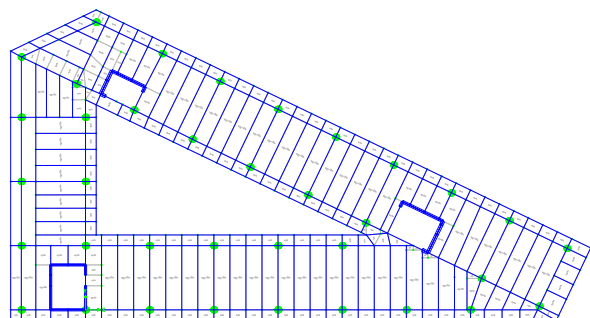
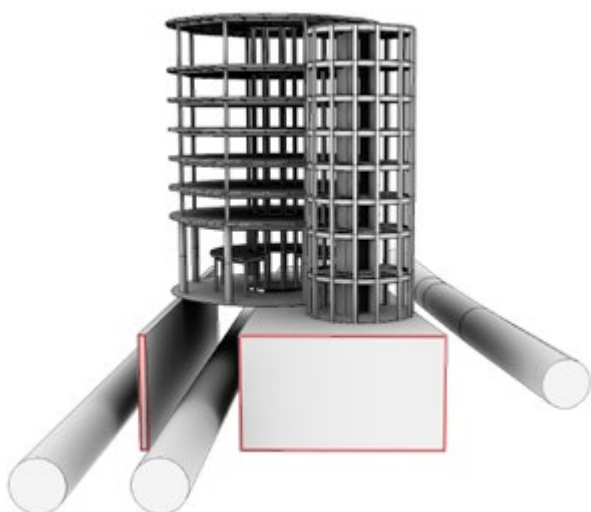



Above and right: Construction images of the development which brings together highly efficient, office buildings, with shops, restaurants and a range of civic spaces.



Musée Narbo Via

Narbonne, France 2012 – 2018

Once a vital Roman port, the city of Narbonne in southern France has an impressive legacy of buildings, ancient relics and archaeological sites. The Musée Régional de la Narbonne Antique will be a new landmark at the entrance to the city, on a site adjacent to the Canal de la Robine. The landscaping reinforces the connection with the water to create a tranquil natural setting. Inspired by formal French gardens and the Roman courtyard, the museum's grounds feature an amphitheatre for open-air displays and events.

The centrepiece of the museum is a collection of more than 1,000 ancient stone relief funerary blocks excavated nearby. Their display forms a natural barrier at the heart of the simple, rectilinear building, separating the public galleries from the more private restoration spaces. Visitors will be able to glimpse the work of the archaeologists and researchers through its mosaic of stone and light, and the flexible display framework allows the reliefs to be easily reconfigured and used as an active tool for learning.



The building incorporates galleries for permanent and temporary exhibitions, a multimedia education centre and library, as well as restoration and storage facilities. These spaces are arranged over a single storey with administrative offices at mezzanine level and are unified beneath a concrete roof canopy, which provides thermal mass and contributes to a comprehensive environmental strategy. The canopy is elevated above a clerestory, punctuated with light wells, and it extends to shade a wide public plaza around the museum.

Client

Region Languedoc Roussillon

Site Area

22,000m²

Building Area

10,700m² Gross

Services

Architecture
Structural Engineering
Environmental Engineering



The building consists of a precast white concrete roof, positioned over architectural concrete walls and columns, with a partial mezzanine.

To increase the visual impact of the museum and offset flooding risks, the building is elevated by a podium forming a technical void. Floor slabs are hollow core precast planks with, locally, in-situ concrete slabs.

The imposing roof structure, forming a 100m wide square, consists of a ribbed slab spanning between deep primary beams. It provides partial shading at the perimeter via 4 to 9 metre long cantilevers. The inner columns are positioned on a 12m by 15m grid.

The apparent simplicity of the building is made possible by a clever use of the architectural features, including the façade walls and exposed roof structure. In particular, innovative detailing was developed to resist the mild seismic forces and limit the significant thermal variations found in the region, with minimal visual impact to the original architectural intent.

To emphasize the regional nature of the museum, the system used for the exposed façade walls is equivalent to rammed earth construction. These walls, that provide also the lateral stability system of the building has been made of a dry mix concrete using local aggregates. Careful detailing took into consideration the structural demands of the walls with the constraints imposed by the construction methods of this type of system.

Below: Construction of the façade walls.



Structural diagram.

Aerial view of the construction site.

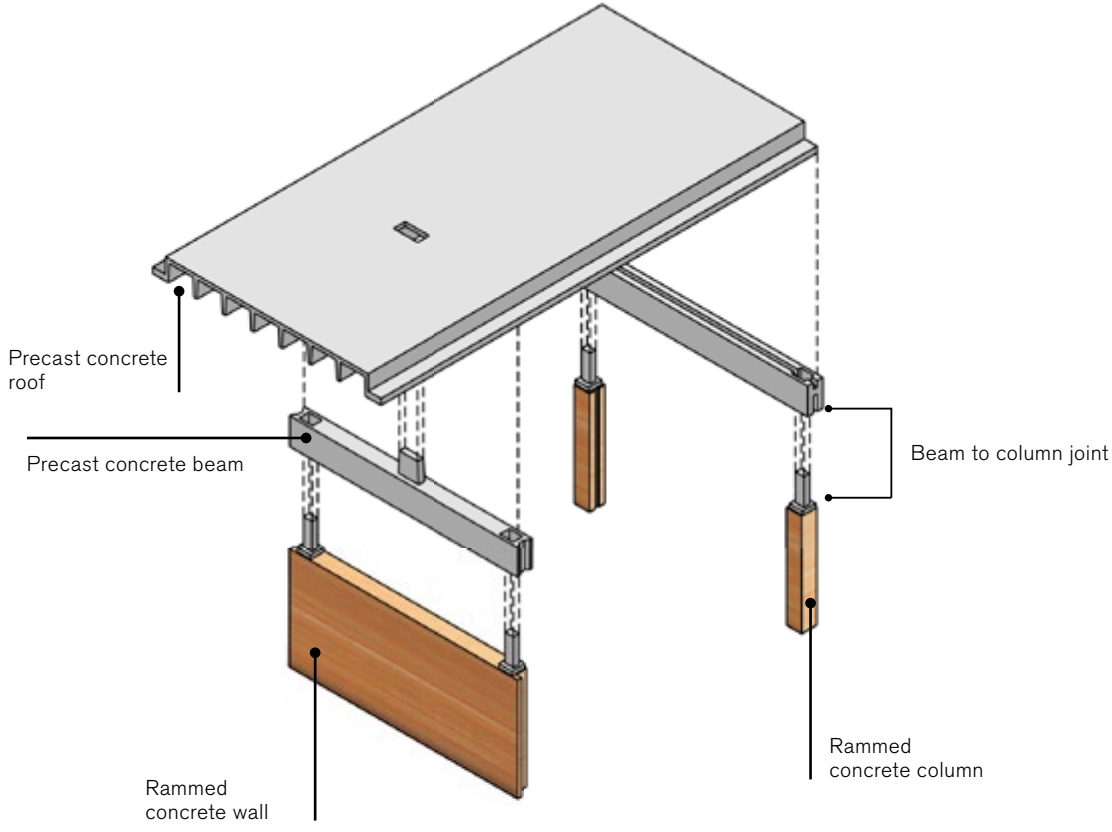

Marseille Vieux Port

Marseille, France 2010 – 2013

Marseille's Vieux Port is one of the grand Mediterranean ports, but over time the World Heritage-listed site has become inaccessible to pedestrians and has been cut off from the life of the city. The masterplan for its regeneration reclaims the quaysides as a civic space, creating new informal venues for performances and events and removing traffic to create a safe, semi-pedestrianised public realm.

Enlarging the space for pedestrians, the technical installations and boat houses on the quays have been replaced with new platforms and clubhouses over the water. The landscape design, which was developed with Michel Desvigne, includes a new pale granite surface, which echoes the shade of the original limestone cobbles. Planting is kept to a minimum in favour of hard-wearing, roughly textured materials appropriate to the port setting. The design eliminates kerbs and changes in level to improve accessibility, as well as using removable cast iron bollards to maximise flexibility.

Using very simple means, the space is enhanced with small, discreet pavilions for events, markets and special occasions. At Quai des Belges, the prominent eastern edge of the harbour, a dramatic blade of reflective stainless steel shelters a flexible new events pavilion. Open on all sides, its 46 by 22 metre canopy is supported by slender columns – the canopy's polished, mirrored surface reflects the surrounding port and tapers towards the edges, minimising its profile and reducing the structure's visual impact.

Client

Marseille Provence Metropole

Canopy Area

1,250m²

Services

Architecture

Structural Engineering

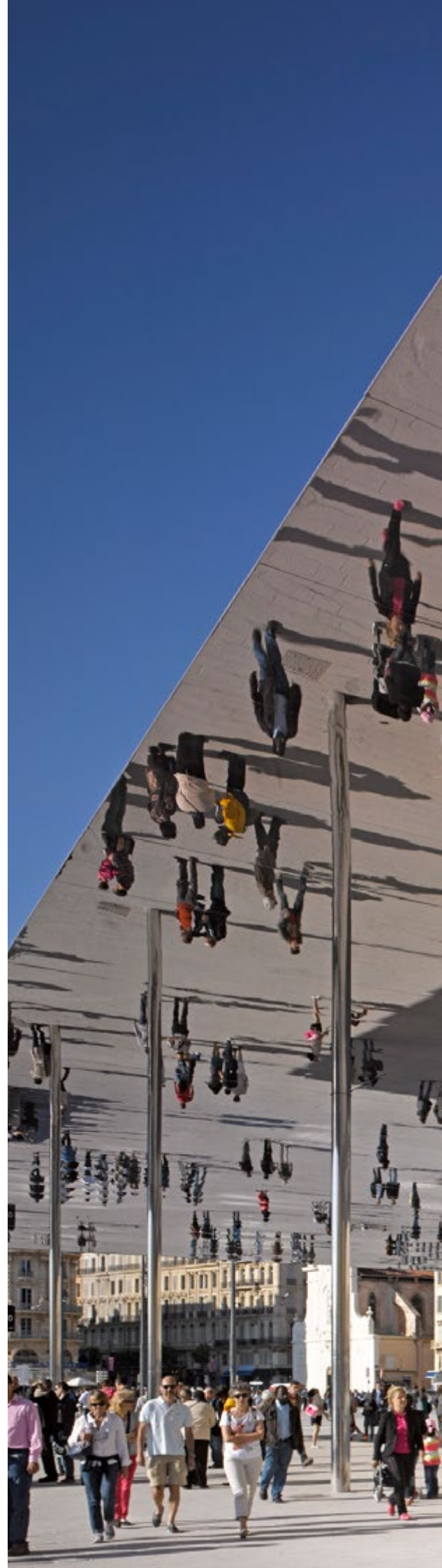



The key challenge for the structural elements of the project was to create a flat and ridged surface to which the mirror panels could be fixed.

Mirror is very unforgiving, highlighting and amplifying all deflections and distortions.

The canopy profile had to be as shallow as possible, in particular for aerodynamic reasons, so as to let strong coastal winds pass over and under it. The structural engineering team at Foster + Partners designed fabricated plate girders that gently tapered to a shallow edge.

The rain gutter was moved back from the edge and was integrated within the tapered beams to

minimise impact on the edge profile. Rainwater feeds directly into the slender columns, integrating drainage and structure in one element.

The mirror panels themselves were stiffened to minimise deflections. The stainless steel surfaces were laminated to aluminium honeycomb, creating stiffer yet lightweight sandwich panels to ensure that the reflective surface remained flat.

The underside of the canopy is formed from highly polished stainless-steel panels and acts as a mirror for the sea and life of the port.

Below: Construction of the mirrored panels.



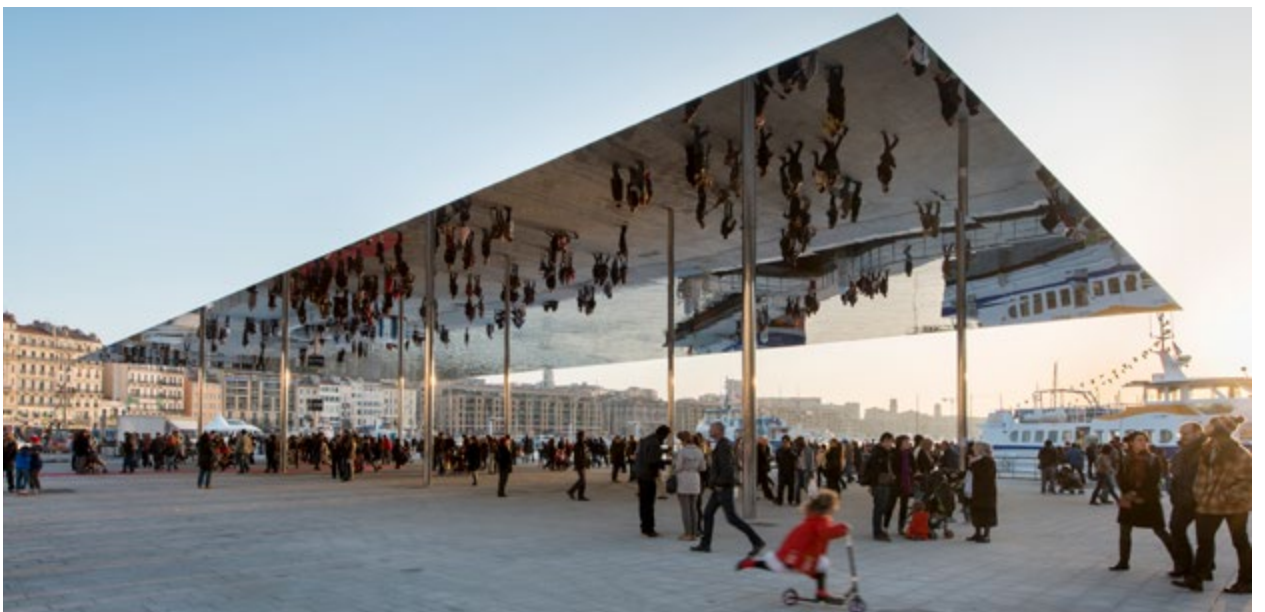

Maggie's Centre at The Christie

Manchester, UK 2012 – 2016

The Maggie's Centres are conceived to provide a welcoming 'home away from home' – a place of refuge where people affected by cancer can find emotional and practical support. The centres are located across Britain and, inspired by the blueprint for a new type of care set out by and its leading oncology unit.

Inspired by the blueprint for a new type of care set out by Maggie Keswick Jencks, they place great value upon the power of architecture to lift the spirits and help in the process of therapy. The design of the Manchester centre aims to establish a new rapport between architecture and the landscape and, appropriately, is first glimpsed at the end of a tree-lined street, a short walk from The Christie Hospital occupies a sunny site and is arranged over a single storey, keeping its profile low and reflecting the residential scale of the surrounding streets. The roof rises in the centre to create a mezzanine level, naturally illuminated by clerestory glazing, and it is supported by lightweight beams and a timber lattice, inspired by the structure of an aircraft. The beams act as natural partitions between different areas internally, while the southern part of the structure is planted with vines, visually dissolving the architecture into the surrounding gardens. The centre combines a variety of spaces, from intimate, private niches to a library, exercise rooms and places to gather and share a cup of tea. The heart of the building is the kitchen, which is centred on a large, communal table. Throughout the building, institutional references, such as corridors and

hospital signs, are eliminated and the materials palette combines warm, natural wood and tactile fabrics, such as felt. Staff will be unobtrusive, yet close and accessible. Support offices and private rooms are placed on a mezzanine level within a wide central spine, with toilets and storage spaces below, maintaining natural visual connections across the building.

Throughout the centre, there is a focus on natural light, greenery and garden views. The rectilinear plan is punctuated by landscaped courtyards and the entire western elevation extends into a wide veranda, which is sheltered from the rain by the deep overhang of the roof. Sliding glass doors open the building up to a magnificent green setting created by Dan Pearson Studio, and each treatment and counselling room on the eastern façade faces its own private garden. A greenhouse extends from the south of the building, where it is integrated with the structure like the cockpit of an aircraft. The greenhouse provides a garden retreat, a space for people to gather, to work with their hands and enjoy the therapeutic qualities of nature and the outdoors, while protected from the rain.

Client

Maggie's Centres

Site Area

1,922m²

Services

Architecture

Structural Engineering

Environmental Engineering



The structure is virtually entirely envisaged in timber, with the main frames, at 3m centres, being the principal architectural feature of the building.

The typical latticed frames, inspired by the “Belfast truss” from the early 20th century, provides the main gravity resisting system for the building - together lateral stability in the transverse direction.

The central mezzanine spine is an independent structure that use domestic-scale floor and board construction supported on two cross laminated timber (CLT) walls. Lateral stability in the longitudinal direction is provided by two sets of braced bays at both ends of the building. Sandwich roof panels with integrated insulation span between the main frames carry the roof finishes and snow loading.

The main frames are designed in laminated veneer lumber (LVL), which offers superior material strength than ordinary softwood due to the grain alignment. This leads to minimised member sizes. The lattice pattern, forming the web of the main horizontal beams, reflects the structural demand in the structure. As the shear forces increase towards the supports, the web becomes more solid; conversely, towards mid-span, where the shear demand is low, the web has more voids.

A similar approach is adopted in the flange members, which taper from a maximum width of 130mm to a minimum width of 55mm. Following consultation with various timber manufacturing specialists, CNC'd web openings were identified as leading to an optimised design that reflects the structural requirements at every point.

Timber elements will be manufactured off site and delivered to Manchester allowing a faster construction phase and providing an immediate sheltered space for finishing works to be carried out.

Maggie's centre was shortlisted for the IStructE Awards in the 'Education and Healthcare Structures' category in 2016. It received both the Arnold Laver Gold Award and the Structural Award at the 2016 Wood Awards, and the Structural Timber Awards in two categories: 'Best Healthcare Project' and 'Architect of the year'.

Timber node detail.

Exploded view of a single frame element.

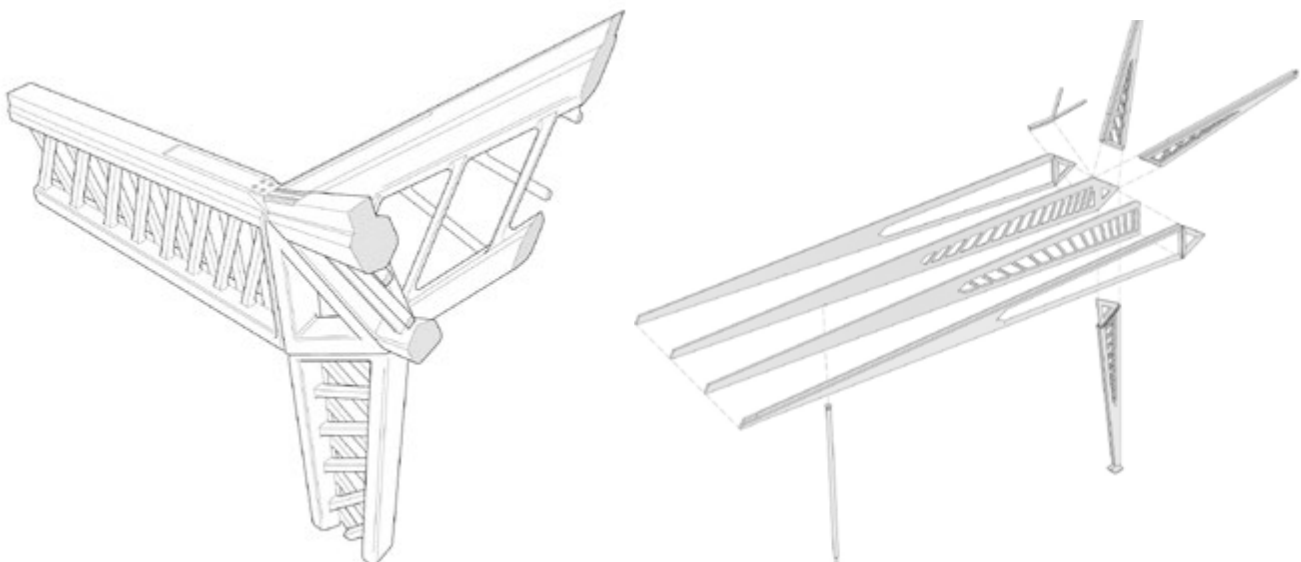



Construction time line of the timber frame.



New International Airport

Mexico City, Mexico 2014 – 2020

A collaboration between Foster + Partners, FR-EE and NACO won the international competition to design Mexico City's new international airport. At 470 000m², it will be one of the world's largest airports and will revolutionise airport design – the entire terminal is enclosed within a continuous lightweight gridshell, embracing walls and roof in a single, flowing form, evocative of flight. The design ensures short walking distances and few level changes, it is easy to navigate, and passengers will not have to use internal trains or underground tunnels – it is a celebration of space and light. Flexible in operation, its design anticipates the predicted increase in passenger numbers to 2028 and beyond, and its development will be the catalyst for the regeneration of the surrounding area. The airport is planned on a new site with three runways, and an expansion plan up to 2062 with an eventual six runways.

With spans in excess of 100m, three times the span of a conventional airport, it has a monumental scale inspired by Mexican architecture and symbolism. The maximum span internally is 170m. The lightweight glass and steel structure and soaring vaulted roof are designed for Mexico City's challenging soil conditions. Its unique pre-fabricated system can be constructed rapidly, without the need for scaffolding – the airport will be a showcase for Mexican innovation, built by Mexican contractors and engineers.

The entire building is serviced from beneath, freeing the roof of ducts and pipes and revealing the environmental skin. This hardworking structure

harnesses the power of the sun, collects rainwater, provides shading, directs daylight and enables views – all while achieving a high performance envelope that meets high thermal and acoustic standards. The LEED Platinum design works with Mexico City's temperate, dry climate to fill the terminal spaces with fresh air using displacement ventilation principles. For a large part of the year, comfortable temperatures will be maintained by almost 100% outside air, with little or no additional heating or cooling required.

Foster + Partners carried out the structural and environmental engineering for the competition and sustainability design support throughout the project stages.

Client

NAICM Nuevo Aeropuerto
Internacional de la Ciudad de
México

Site Area

470,000m²

Services

Architecture
Structural Engineering
(Competition)
Environmental Engineering
(Sustainability)

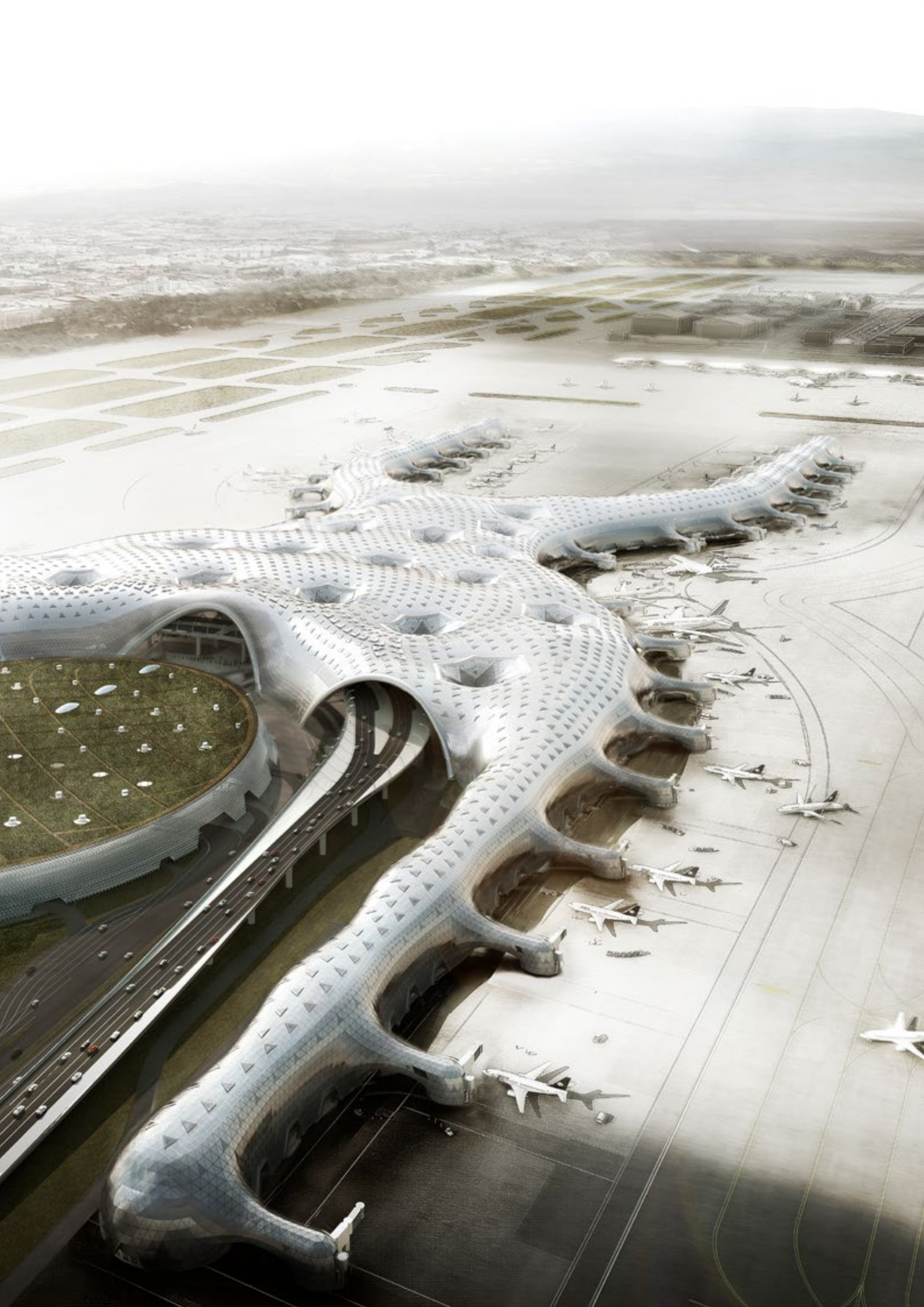

The winning entry at the international design competition for the proposed new airport for Mexico City was the result of a close collaboration between the architectural and engineering teams at Foster + Partners and our joint venture architecture partner, Fernando Romero Enterprises.

The importance of the expression of the structure in the overall design meant that the competition phase benefited from an integrated approach, with an attention to structural detail that is unusual at such an early stage.

The new airport will be situated in an area free from existing development, north-east of the city centre, known as Lake Texcoco. The area is subject to seasonal flooding and the soil is extremely soft, suffering from a high rate of ongoing settlement caused in part by water extraction from a nearby sub-surface aquifer. Foundation and seismic engineering is extremely complex for this site. Detailed site specific seismic modelling was required to predict the behaviour, given the very long period of the soils and the unusual basin effect typical of the lake area in Mexico City.

The roof is the most exciting structural element in the scheme. With typical spans of 100m and a maximum span of 160m in the central dome. It demonstrates the ability to generate large-span spaces through the application of geometry and curvature. It is made up of a triangulated steel space

frame structure creating a skin which is approximately 2.5m thick. This behaves in a funicular way under gravity loads, with the principle demonstrated by a hanging chain scale model, referencing the techniques of engineers such as Frei Otto. At the building perimeter, the roof curves down to the ground which provides a line support. However, the roof is also supported on a small number of large funnel shaped columns, which perform a number of operational and building service tasks as well, such as bringing fresh air into the building. Stability is provided through the perimeter line supports and cantilever action from the columns.

The superstructure and the roof are conceived as separate entities, allowing design and construction to be independent. The internal superstructure is relatively conventional as it is formed using concrete filled metal deck with composite beams and braced frames for stability. Given the scale and complexity of the project, the Foster + Partners engineering team remains involved in the project acting as a link between the architectural team and the external project structural engineers, Arup.

Right (top to bottom): Roof dome first buckling mode shape.

Roof dome model undeformed.

Roof exploded view.

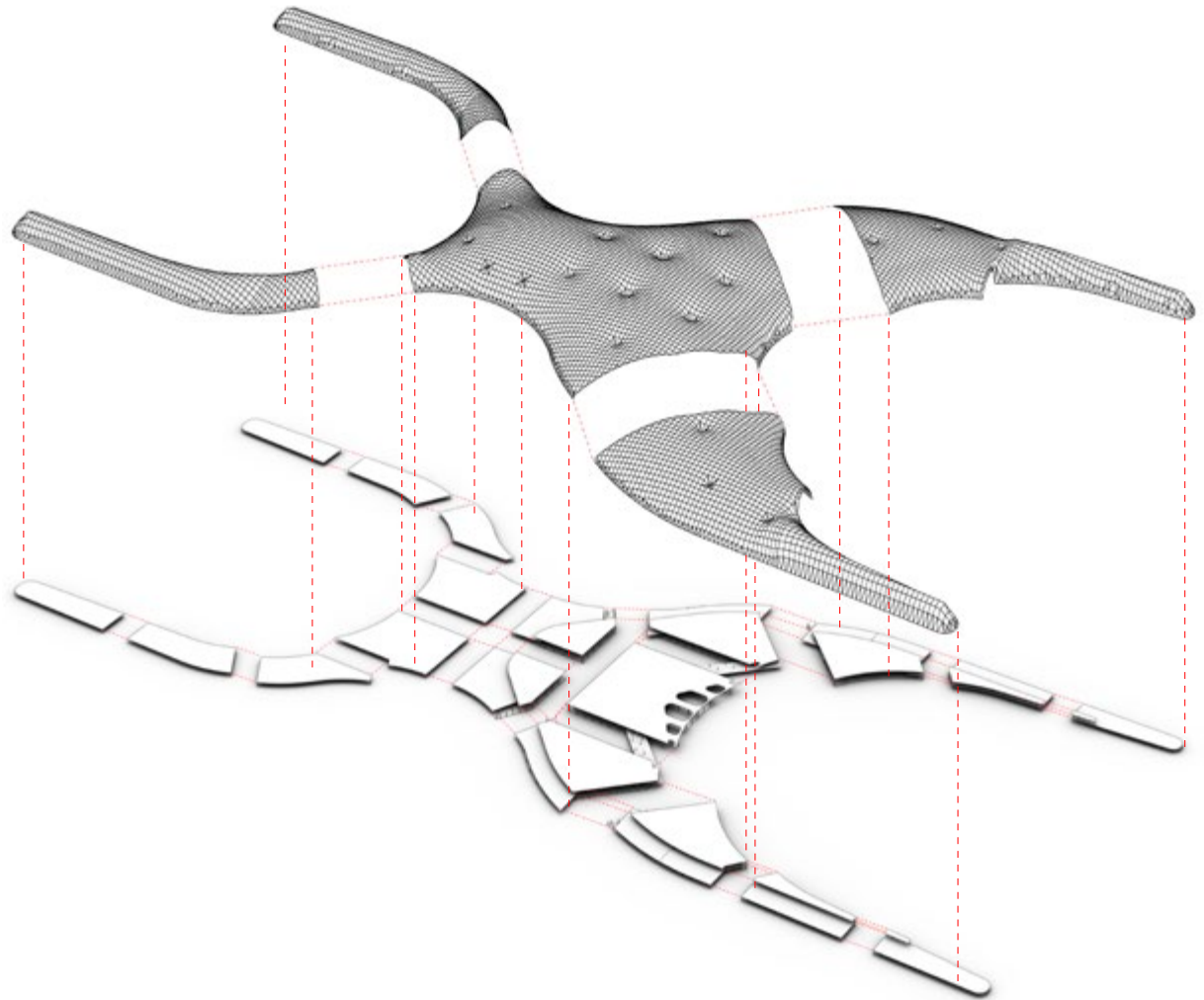
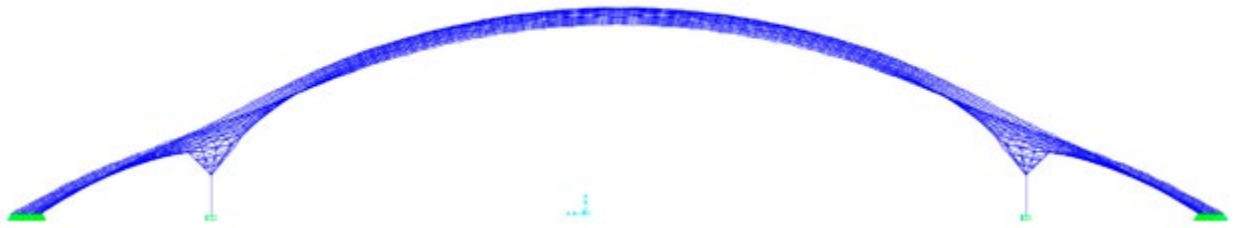
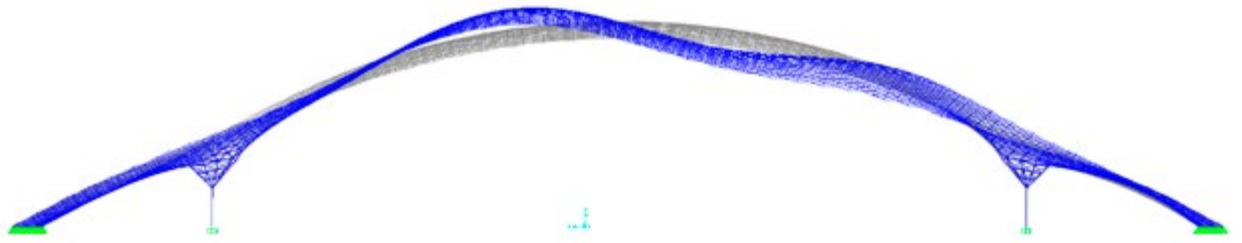

Ocean Towers

Mumbai, India 2016 – 2020

Ocean Towers is a premium residential project that brings global urban living to Mumbai. Located at the heart of the 'Queen's Necklace' bay area, adjacent to the coastal boulevard Marine Drive and the Arabian Sea, the 424m building will be a landmark for the city and the tallest tower in India.

The tower features 270 dual aspect apartments with panoramic sea views. The 93-storey twin towers are orientated east-west to take advantage of the sea-breeze, and are arranged radially for privacy and structural integrity. The structure braced by trusses that tie the towers together at every 12 floors to ensure stability. These also house the exceptional sky villas – apartments that span across the tower floorplates with 360-degree views and individual private swimming pools. At the top of the building are the penthouses with unmatched views of the coast towards the east and the west, and the ballroom – an event space surrounded by roof gardens for private residents.

A ten-storey stepped podium accommodates extensive amenity facilities set within lush terraced gardens. Residents have access to a state-of-the-art sports centre with courts for tennis, squash and basketball, billiards room and swimming pool, along with luxurious spa and gym facilities. The podium also features a full-service business centre and café. The car park is located below the podium, with 6 levels of basement parking, accommodating 700 cars in total.

Client

DB Hospitality Private Limited

Site Area

156,453m²

Services

Architecture

Structural Engineering

Environmental Engineering



The two towers are structurally independent above the shared podium level.

Each tower is in reinforced concrete. The lateral system consists of a central reinforced concrete core with outriggers in three locations over the height of the building. The seismic and wind loads along the long axis of the core are resisted by the core alone. In the orthogonal axis, across the width of the building, the outriggers mobilise the columns in each corner of the floorplate to work in tandem with the core.

As a result of this lateral system, the need for the further intermediate columns which would have been required for a moment frame have been avoided.

Previous scheme and current scheme as a result of the lateral stability system.

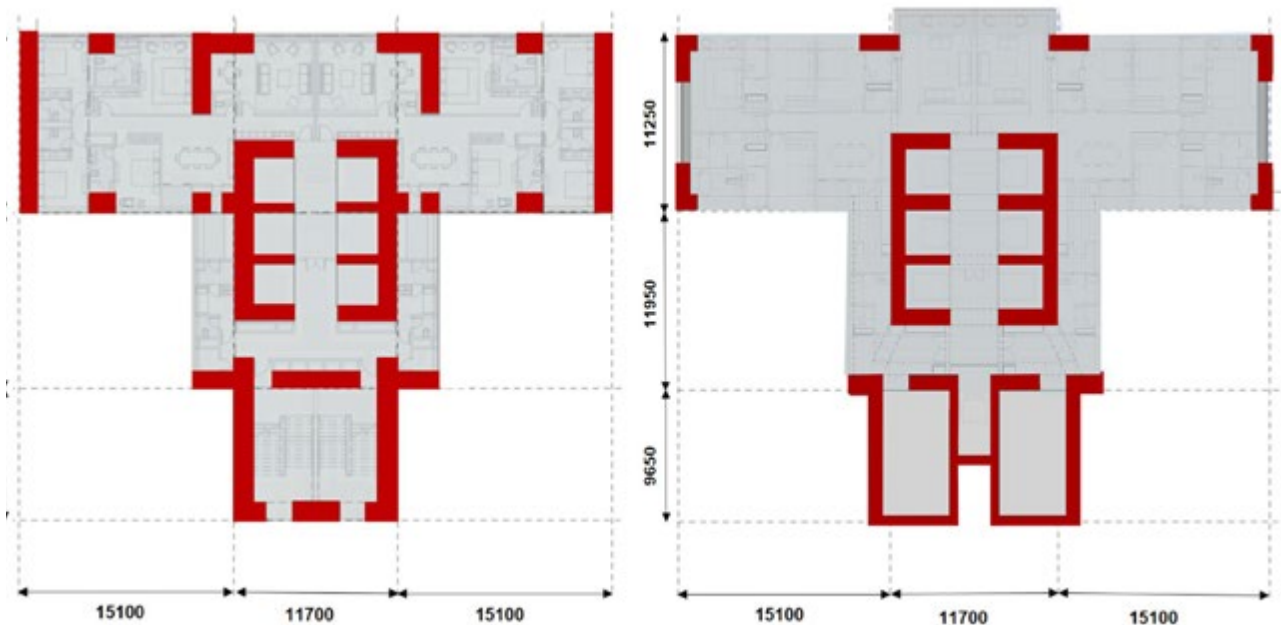

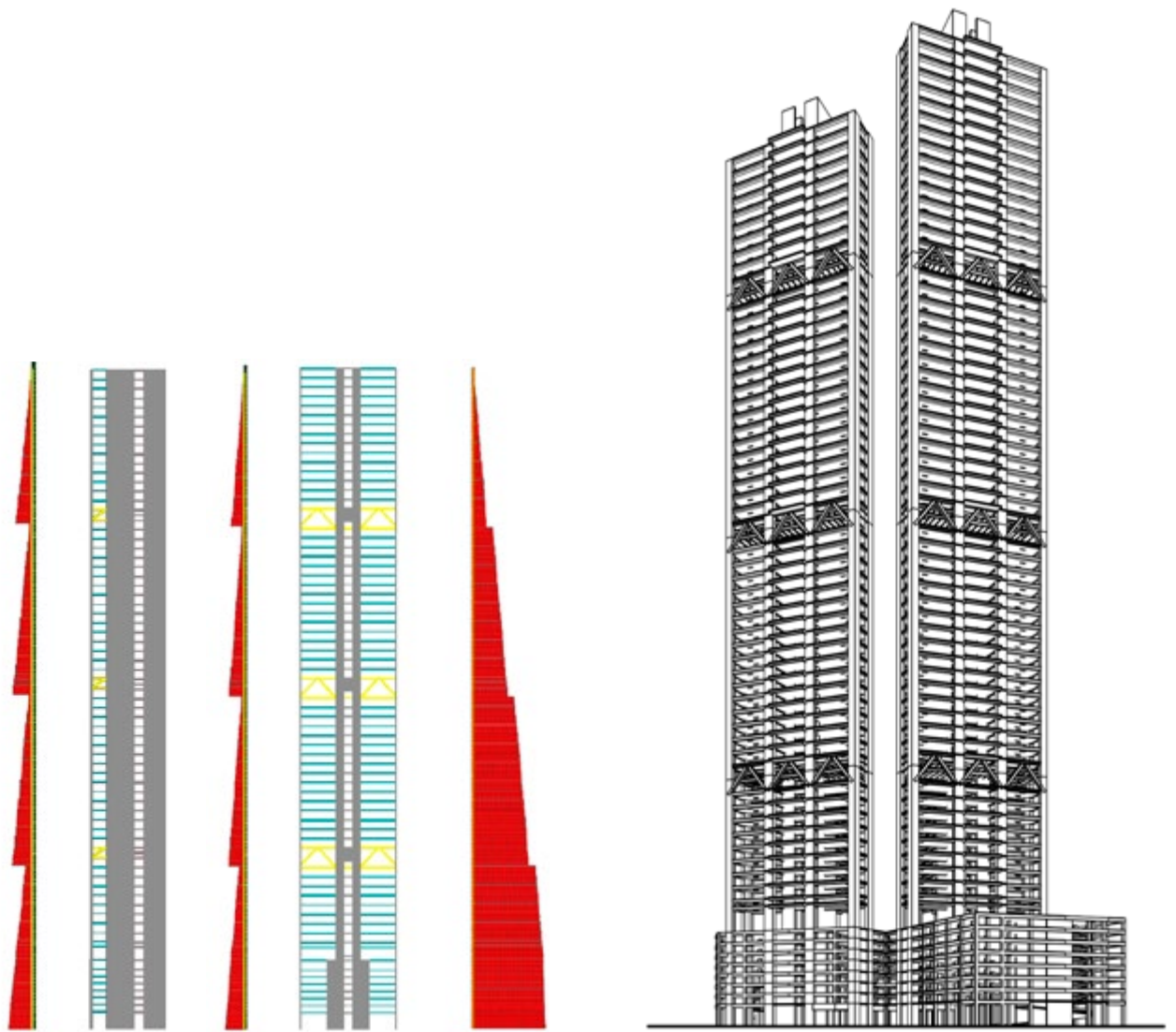

Above: Structural analysis diagrams for the lateral stability system. 3D model.

MOL Campus

Budapest, Hungary 2017 – 2021

MOL Campus is the new headquarters for the MOL Group, a global oil and gas company based in Hungary. The new building consolidates the company's operations in one place, while creating an exciting new addition to the city's skyline.

An integral part of the MOL Group's sustainable vision for 2030, the building provides a blueprint for the office of the future. Its unique form integrates a 27-storey tower with a podium a single form to create a unified campus. The lower floors house restaurants, a gym, conference centre and a whole host of other facilities for staff, while the flexible offices spaces are on the upper levels.

Greenery travels through the heart of the building, from the central atrium to the rooftop, bringing nature closer to the workspace. It also acts as a social catalyst, creating spaces for collaboration, relaxation and inspiration. The offset service cores create large flexible areas that encourage collaborative patterns of working. Using cutting edge technology to control light levels, temperature and views these workspaces are finely calibrated to create the perfect working environment, a light filled inspirational space for people to work in.

Setting a new benchmark both for Budapest and Hungary, the design of the building makes the most of its urban context to drive a sustainable response. The MOL Campus seeks to preserve live-work relationships as part of the urban experience, where people are able to walk or cycle to work. All occupants have a direct connection to the external environment providing fresh air, daylight and views. The building utilises low and zero carbon energy sources, such as photovoltaics, and features rainwater harvesting and storage facilities.

Client
MOL Group

Area
58,500m²

Team
Finta Studio





When complete, the MOL Tower will be the tallest building in Budapest at a height of 120m.

It will provide 29 floors of premium office space with sweeping views towards the city.

Framed in unbonded post-tensioned concrete to achieve the large column-free spans required by the architectural design intent, the tower structure is optimised to withstand wind and seismic loads.

The lateral stability is provided by a dual system, which comprises two high-strength concrete cores and a series of braced frames. While the concrete cores are the primary lateral force-resisting system, additional redundancy and energy dissipation under seismic shaking is provided by buckling restrained braces (BRBs) at the braced bays.

Adjacent to the tower, and separated via a full height seismic joint, is a low-rise structurally independent podium to accommodate amenities and additional office areas.

The podium is entirely framed in reinforced concrete. A large basement, 4 stories deep, provides accommodation for parking.



Bottom left and right: Structural BIM model.

Below: Lateral stability system diagram.

Flat slab deflection of the Podium structure.

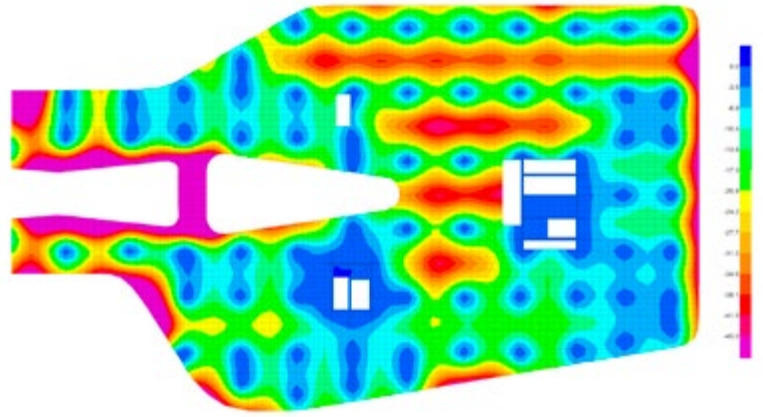
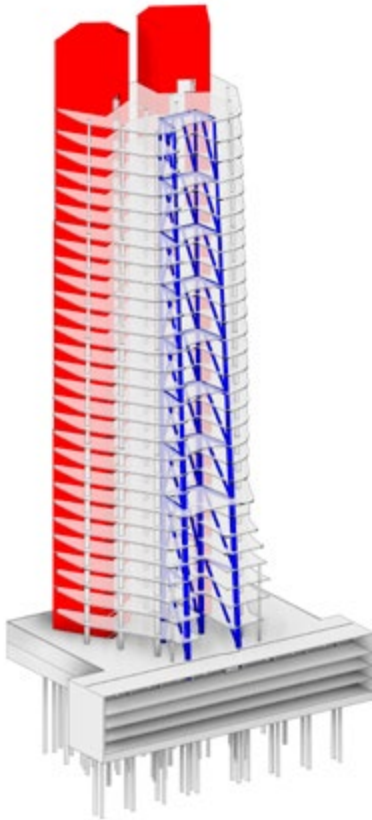



“As an architect you design for the present, with an awareness of the past, for a future which is essentially unknown..”

Norman Foster

Executive Chairman and Founder, Foster + Partners





